



# Carbon Monoxide Alarm User's Guide

Models: **KN-COB-B-LP** and  
**KN-COPP-B-LP** (with Digital Display)



**KN-COB-B-LP**



**KN-COPP-B-LP**  
with Digital Display

- Digital Display
- Peak Level Memory
- 3-AA Battery Operation

**ATTENTION:** Please take a few minutes to thoroughly read this user's guide which should be saved for future reference and passed on to any subsequent owner.

# What to do When the Alarm Sounds!

## Carbon Monoxide Alarm Procedure



**WARNING:** Activation of the CO Alarm indicates the presence of Carbon Monoxide (CO) which can kill you.

- 1) Operate the Test/Reset button;
- 2) Call your emergency services (Fire Department or 911);

PHONE NUMBER:

- 3) Immediately move to fresh air - outdoors or by an open door/window. Do a head count to check that all persons are accounted for. Do not reenter the premises nor move away from the open door/window until the emergency services responders have arrived, the premises have been aired out, and your alarm remains in its normal condition.
- 4) After following steps 1-3, if the alarm reactivates within a 24 hour period, repeat steps 1-3 and call a qualified appliance technician to investigate sources of CO from fuel burning equipment and appliances, and to inspect for proper operation of equipment.

PHONE NUMBER:

If problems are identified during this inspection, have the equipment serviced immediately. Note any combustion equipment not inspected by the technician and consult the manufacturer's instructions, or contact the manufacturer's directly for more information about CO safety and the equipment. Make sure that motor vehicles are not, or have not been, operating in a garage attached or adjacent to the residence.

**Never restart the source of a CO problem until it has been corrected. Never ignore the sound of the alarm!**

**If the alarm is sounding, pressing the test/reset button will terminate the alarm. If the CO condition that caused the alert in the first place continues, the alarm will reactivate. If the unit alarms again within six minutes, it is sensing high levels of CO which can quickly become a dangerous situation.**

## Welcome

**Note: Many times throughout this User's Guide, we will refer to Carbon Monoxide as "CO".**

This Kidde carbon monoxide (CO) alarm is an important part of your family's home safety plan. This alarm has been designed and tested to detect CO buildup in a residential environment. Your alarm is for use specifically in the home. As an owner of a CO alarm, there are some basic facts you should know about for your protection.

Many people think that CO alarms operate like smoke alarms. Like smoke alarms, CO alarms monitor the air in your home and sound a loud alarm to warn you of trouble. The way you respond to a CO alarm is quite different than a smoke alarm. That's because a house fire and a CO problem are two distinctly different situations. If your smoke alarm were to alarm, you would quickly be able to judge the level of danger you were in with your senses. You can see and smell the smoke, feel the heat, see, and possibly hear the fire burning. You can also readily see if your smoke alarm is alarming in a non-emergency situation. Because your sense of sight, smell, hearing and touch give you information, you can almost instantly judge what action to take if you hear your smoke alarm.

CO is an invisible, odorless, tasteless and non-irritating gas – completely undetectable to your senses. That's why it is important to your safety that you have a CO alarm.

## Important Warning Statements

**IMPORTANT: This carbon monoxide alarm is designed to detect carbon monoxide from ANY source of combustion. It is NOT designed to detect smoke, fire, or any other gas.**

 **WARNING:** Carbon monoxide alarms are not smoke alarms. This carbon monoxide alarm is not a substitute for installing and maintaining an appropriate number of smoke alarms in your home.

**This carbon monoxide alarm will not sense smoke, fire, or any poisonous gas other than carbon monoxide even though carbon monoxide can be generated by fire. For this reason you must install smoke alarms to provide early warning of fire and to protect you and your family from fire and its related hazards.**

**CAUTION: This alarm will only indicate the presence of carbon monoxide at the sensor. Carbon monoxide may be present in other areas.**

## Important Warning Statements

 **WARNING:** This product is intended for use in ordinary indoor locations of family living units. It is not designed to measure compliance with Occupational Safety and Health Administration (OSHA), commercial or industrial standards. It is not suitable for installation in hazardous locations as defined in the National Electric Code.

The installation of this device should not be used as a substitute for proper installation, use and maintenance of fuel burning appliances, including appropriate ventilation and exhaust systems. It does not prevent CO from occurring, nor can it solve an existing CO problem.

 **WARNING:** This device is designed to protect individuals from acute effects of carbon monoxide exposure. It may not fully safeguard individuals with specific medical conditions. If in doubt, consult a medical practitioner.

Individuals with medical problems may consider using warning devices which provide audible and visual signals for carbon monoxide concentrations under 30 PPM.

This carbon monoxide alarm requires a continuous supply of electrical power – it will not work without power.

This alarm has not been independently investigated for carbon monoxide detection below 70 PPM.

## Contents of This User's Guide

1. Information About Carbon Monoxide
2. Product Features and Specifications
3. Installation Locations
4. Installation Instructions
5. KN-COB-B-LP Operating Characteristics
6. KN-COPP-B-LP (with digital display) Operating Characteristics
7. Alarm Characteristics
8. Maintenance
9. Limited Warranty

# 1. Information About Carbon Monoxide

## General Carbon Monoxide Information

Carbon monoxide is a colorless, odorless and tasteless poison gas that can be fatal when inhaled. CO inhibits the blood's capacity to carry oxygen.

Periodically review this user's guide and discuss your CO alarm emergency procedure with all the members of your family. Never ignore a CO alarm. A true alarm is an indication of potentially dangerous levels of CO. CO alarms are designed to alert you to the presence of CO before an emergency – before most people would experience symptoms of CO poisoning, giving you time to resolve the problem calmly.

Determine if anyone in the household is experiencing symptoms of CO poisoning. Many cases of reported CO poisoning indicate that while victims are aware they are not well, they become so disoriented they are unable to save themselves by either exiting the building or calling for assistance. Also, young children and household pets may be the first affected. You should take extra precautions to protect high-risk persons from CO exposure because they may experience ill effects from CO at levels that would not ordinarily affect a healthy adult.

## Symptoms of CO Poisoning

The following common symptoms are related to CO poisoning and should be discussed with ALL members of the household.

### Mild Exposure:

Slight headache, nausea, vomiting, fatigue (often described as "flu-like" symptoms).

### Medium Exposure:

Severe throbbing headache, drowsiness, confusion, fast heart rate.

### Extreme Exposure:

Unconsciousness, convulsions, cardio-respiratory failure, death.

If you experience even mild symptoms of CO poisoning, consult your doctor immediately!

# 1. Information About Carbon Monoxide

## **Carbon Monoxide PPM Levels (model KN-COPP-B-LP with digital display only)**

Model KN-COPP-B-LP is equipped with a digital display that shows levels of CO (displayed in PPM – parts per million). Learn the difference between dangerous, high, mid and low levels.

### **Dangerous Levels:**

When someone is experiencing symptoms of CO poisoning and CO readings are generally above 100 PPM. Anytime someone is experiencing the symptoms of CO poisoning this should be treated as an emergency. See “What to do When the Alarm Sounds” (inside front cover).

### **High Levels:**

Generally above 100 PPM, with no one experiencing symptoms. This should be treated as an urgent situation. See “What to do When the Alarm Sounds” (inside front cover).

### **Mid Levels:**

Generally between 50 PPM to 100 PPM. This should be cause for concern and should not be ignored or dismissed. See “What to do When the Alarm Sounds” (inside front cover).

### **Low Levels:**

Generally below 50 PPM. Kidde recommends you take action to eliminate the source of CO. See “What to do When the Alarm Sounds” (inside front cover).

**IMPORTANT: Model KN-COB-B-LP does not have a digital display and does not display carbon monoxide levels in PPM. If the alarm sounds, it should be treated as a potentially serious condition.** See “What to do When the Alarm Sounds” (inside front cover).

## **Possible Sources of Carbon Monoxide**

Inside your home, appliances used for heating and cooking are the most likely sources of CO. Vehicles running in attached garages can also produce dangerous levels of CO.

CO can be produced when burning any fossil fuel, such as gasoline, propane, natural gas, oil and wood. It can be produced by any fuel-burning appliance that is malfunctioning, improperly installed, or not ventilated correctly, such as:

- Automobiles, furnaces, gas ranges/stoves, gas clothes dryers, water heaters, portable fuel burning space heaters and generators, fireplaces, wood-burning stoves and certain swimming pool heaters.
- Blocked chimneys or flues, back drafts and changes in air pressure, cor-

# 1. Information About Carbon Monoxide

roded or disconnected vent pipes, loose or cracked furnace exchangers.

- Vehicles and other combustion engines running in an open or closed garage, attached or near a home.
- Burning charcoal or fuel in grills and hibachis in an enclosed area.

## Conditions That Can Produce Carbon Monoxide

The following conditions can result in transient CO situations:

- Excessive spillage or reverse venting of fuel-burning appliances caused by outdoor ambient conditions, such as, wind direction and/or velocity, including high gusts of wind, heavy air in the vent pipes (cold/humid air with extended periods between cycles).
- Negative pressure resulting from the use of exhaust fans.
- Simultaneous operation of several fuel-burning appliances competing for limited internal air.
- Vent pipe connections vibrating loose from clothes dryers, furnaces, or water heaters.
- Obstructions in, or unconventional, vent pipe designs which can amplify the above situations.
- Extended operation of unvented fuel-burning devices (range, oven, fireplace, etc.).
- Temperature inversions which can trap exhaust gases near the ground.
- Vehicle idling in an open or closed garage, or near a home.

To be safe, know the possible sources of CO in your home. Keep fuel-burning appliances and their chimneys and vents in good working condition. Learn the early symptoms of exposure, and if you suspect CO poisoning, move outside to fresh air and get emergency help. Your first line of defense is an annual inspection and regular maintenance of your appliances. Contact a licensed contractor or call your local utility company for assistance.

## Information About Carbon Monoxide Alarms – What They Can and Cannot Do:

CO alarms provide early warning of the presence of CO, usually before a healthy adult would experience symptoms. This early warning is possible, however, only if your CO alarm is located, installed and maintained as described in this guide.

# 1. Information About Carbon Monoxide

Because carbon monoxide is a cumulative poison, long-term exposures to low levels may cause symptoms, as well as short-term exposures to high levels. This Kidde unit has a time-weighted alarm – the higher the level of CO present, the sooner the alarm will be triggered.

This CO alarm can only warn you of the presence of CO. It does not prevent CO from occurring, nor can it solve an existing CO problem. If your unit has alarmed and you've provided ventilation by leaving your windows and doors open, the CO buildup may have dissipated by the time help responds. Although your problem may appear to be temporarily solved, it's crucial that the source of the CO is determined and that the appropriate repairs are made.

This CO alarm is designed to act as a monitor; it is not designed for use as a short-term testing device to perform a quick check for the presence of CO.

CO alarms have limitations. Like any other electronic device, CO alarms are not fool-proof. CO alarms have a limited operational life. You must test your CO alarm weekly, because it could fail to operate at any time.

If your CO alarm fails to test properly, or if its self-diagnostic test reveals a malfunction, immediately have the unit replaced. This alarm will not monitor CO levels while in an error condition.

CO alarms can only sense CO that reaches the unit's sensor. It's possible that CO may be present in other areas without reaching the alarm. The rate and ability that which CO reaches the alarm may be affected by:

- Doors or other obstructions.
- Fresh air from a vent, an open window or other source.
- CO being present on one level of the home and not reach a CO alarm installed on a different level. (For example, CO in the basement may not reach an alarm on the second level, near the bedrooms).

For these reasons, we recommend you provide complete coverage by placing a CO alarm on every level of the home. Please carefully read all information in sections 2 and 3 on properly installing this CO alarm.

CO alarms should not be used to detect the presence of natural gas (methane), propane, butane, or other combustible fuels.

Instruct children never to touch or otherwise interfere with the alarm. Warn children of the dangers of CO poisoning.



## 2. Product Features and Specifications

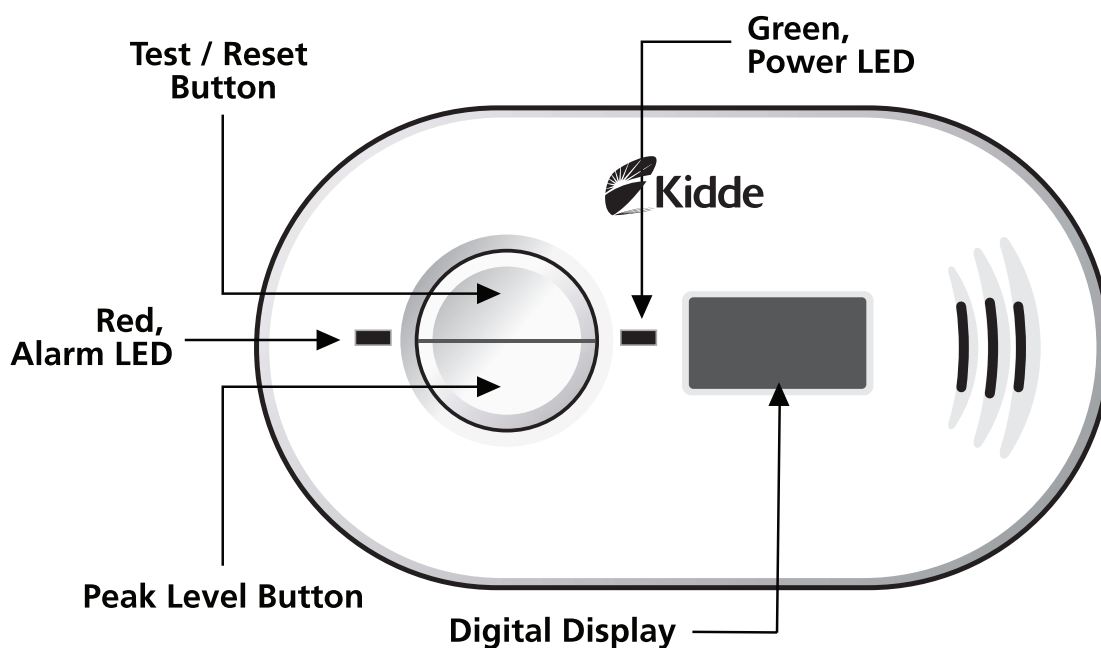
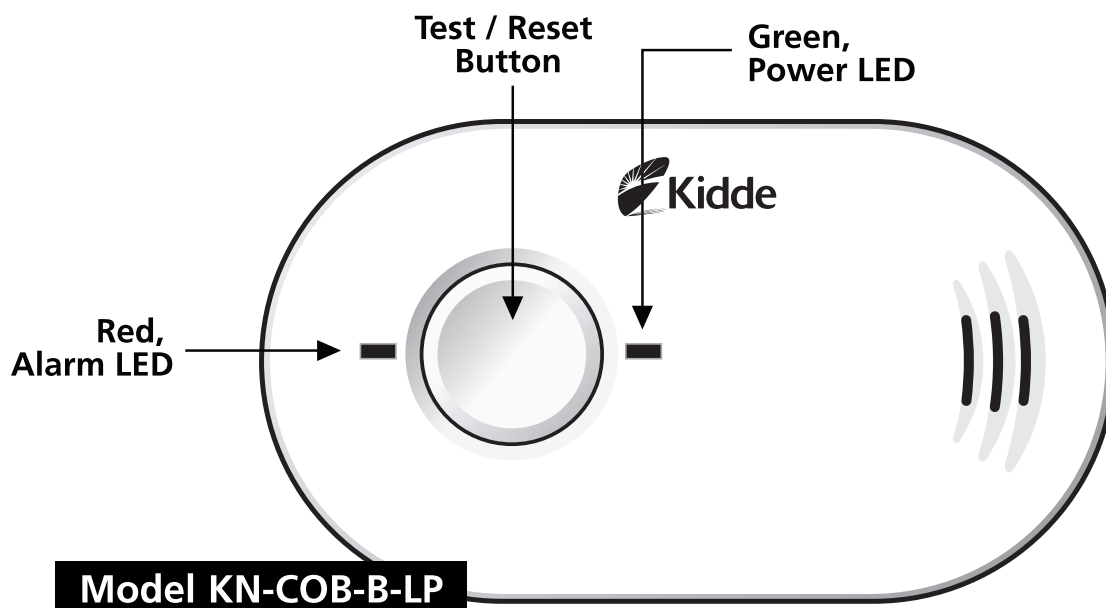

**⚠ WARNING:** After ten (10) years from initial power up, this alarm will “beep” two times every 30 seconds to indicate that it is time to replace the alarm. Replace the alarm immediately! It will not detect CO in this condition.

To help identify the date to replace the alarm, a label has been affixed to the side of the alarm. Write the “replace by” date (ten years from power up) in a permanent marker on this label.

## 2. Product Features and Specifications

### Temperature:

Operating Range: 40°F (4.4°C) to 100°F (37.8°C)

### Humidity:

Operating range: 10-95% non-condensing

### Audible Alarm:

85+ dB at 10' @ 3.4±0.5 KHz pulsing alarm

### Sensor:

Electrochemical

### Power:

3-AA Batteries

### Accuracy of Digital Display: (Model KN-COPP-B Only)

30-999 PPM +/-30% when measured in conditions of 80° F (+/- 10° F), atmospheric pressure +/- 10% and 40% +/- 3% relative humidity. Display readings may vary slightly depending on changes in the ambient condition (temperature, humidity) and the condition of the sensor.

### Alarm Response Times:

70 PPM = 60-240 min., 150 PPM = 10-50 min., 400 PPM = 4-15 min.

## 3. Installation Locations

### Recommended Installation Locations

CO alarms should be mounted in or near bedrooms and living areas. It is recommended that you install a Kidde CO alarm on each level of your home.

When choosing your installation locations, make sure you can hear the alarm from all sleeping areas. If you install only one CO alarm in your home, install it near bedrooms, not in the basement or furnace room.

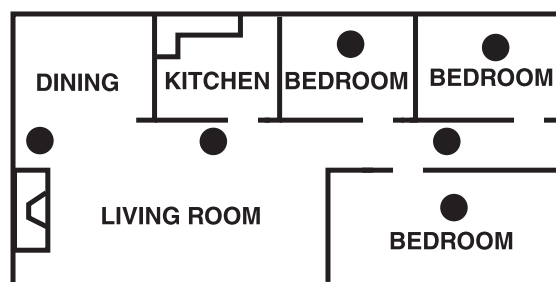

**Recommended Locations**

- When wall mounting, place out of reach of children. Under no circumstances should children be allowed to handle the CO alarm.
- Placing the alarm at eye level allows for optimum monitoring of the digital display.

## 3. Installation Locations

### Locations To Avoid

**IMPORTANT:** Improper location can affect the sensitive electronic components in this alarm. To avoid causing damage to the unit, to provide optimum performance, and to prevent unnecessary nuisance alarms:

- Do not install in kitchens, garages or furnace rooms that may expose the sensor to substances that could damage or contaminate it.
- Do not install in areas where the temperature is colder than 40°F (4.4°C) or hotter than 100°F (37.8°C) such as crawl spaces, attics, porches and garages.
- Do not install within 5 ft. of heating or cooking appliances. (Kidde recommends 15 ft. to prevent nuisance alarms).
- Do not install near vents, flues, chimneys or any forced/unforced air ventilation openings.
- Do not install near ceiling fans, doors, windows or areas directly exposed to the weather.
- Do not install in dead air spaces, such as peaks of vaulted ceilings or gabled roofs, where CO may not reach the sensor in time to provide early warning.
- Do not install this unit near deep-cell large batteries. Large batteries have emissions that can cause the alarm to perform at less than optimum performance.
- Do not obstruct the vents located on the alarm. Do not place the alarm where drapes, furniture or other objects block the flow of air to the vents.

## 4. Installation Instructions

### Battery Installation and Replacement

To install or replace the batteries in this Kidde CO alarm, please perform the following steps.

1. Slide open the bottom cover to expose the battery compartment.
2. If replacing batteries, remove the old batteries and properly dispose of them as recommended by the battery manufacturer.
3. Install the new batteries. Note the polarity illustration in the battery compartment.
4. Close the bottom cover. Note: The bottom cover will not close if all three AA batteries are not installed.

When replacing the batteries, use one of the following approved brands:

- **Duracell MN1500 or MX1500**
- **Energizer E91**
- **Gold Peak 15A**
- **Golden Power GLR6A**

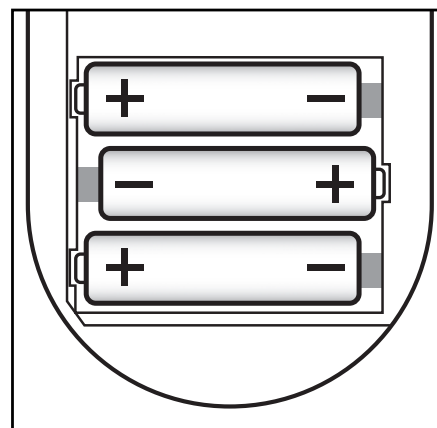

**Battery Polarity  
for the three AA batteries**

These batteries can be purchased where you bought the alarm or at a local hardware store. Use of a different battery may have a detrimental effect on the alarm operation.

**IMPORTANT:** Constant exposures to high or low humidity may reduce battery life. A good safety measure is to replace the battery at least once a year, or at the same time as you change your clocks for daylight saving time.

After installing or changing the batteries, reinstall your alarm. Test your alarm by using the Test/Reset button and check that the green LED flashes once approximately every 30 seconds.

## 4. Installation Instructions

### Mounting

This CO alarm can be either wall mounted or placed on a tabletop.

For wall mounting, follow these steps:

1. Remove back mounting plate from the alarm, place it in the desired location, and mark the location of the two holes needed on the wall
2. Insert the two screws provided until the screw heads are protruding approximately 1/8" from the wall. (If mounting in a plasterboard or drywall, drill a 3/16" hole in the wall and use the plastic anchors provided.)
3. Hook the CO alarm over the screws and onto the keyholes in the back mounting plate of the alarm. After the mounting plate is secured to the wall, slide the alarm down over the mounting plate until it snaps into place.

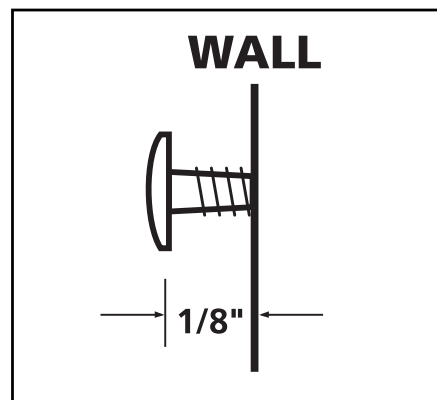

**Screw Head Distance  
from Wall**

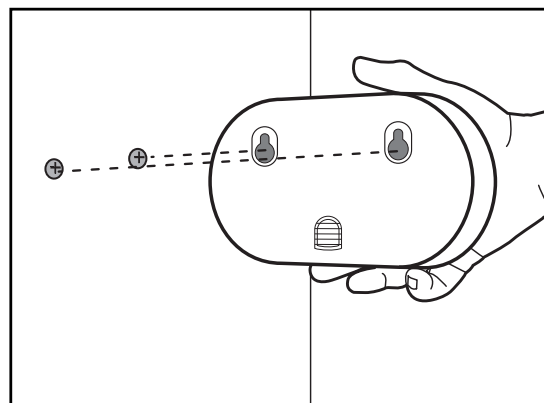

**Wall Mount**

Your CO alarm may also be placed on a tabletop. If the alarm is not wall mounted, be sure it is no more than three feet from the floor. The alarm does not have to be within three feet from the floor to detect CO, but at this height it is less likely to sustain damage from a fall.

### Important Labels Provided

Two labels have been provided that have important information on what to do in case of an alarm. Add the phone number of your emergency service provider in the space provided. Place one label next to the alarm after it is mounted, and one label near a fresh air source such as a door or window.

## 5. Model KN-COB-B-LP Operating Characteristics

Whenever the alarm is operating, the green Power LED flashes every 30 seconds to indicate the unit is monitoring for CO. If the alarm senses dangerous levels of CO, the red Alarm LED will flash and the alarm will emit an audible alarm pattern.

### Operating and Alarm Characteristics

Function	LED Display	Alarm Sound	Unit Status	Recommendation
Normal Operation	Green LED flashes every 30 seconds	None	Normal DC operation (sensing no CO) and with good batteries	None
Carbon monoxide alarm	Red LED flashes with beeps.	4 quick beeps, 5 seconds silence, repeating	Alarm condition. Dangerous concentrations of CO detected	Refer to "What to do When the Alarm Sounds" (inside front cover)
Low battery	Red LED flashes every 60 seconds	One quick beep every 60 seconds	Batteries need to be replaced	Replace all three AA batteries
Error / service alarm	Red LED flashes every 30 seconds	One quick beep every 30 seconds	Unit is in error condition	Replace battery. If condition continues, unit has malfunctioned. Replace immediately. Unit will not respond to CO
Error	Red LED constantly on	Constant alarm	Very low battery or unit malfunction	Replace battery. If condition continues, unit has malfunctioned. Replace immediately. Unit will not respond to CO
Normal Test/Reset function	Red LED flashes with beeps.	4 quick beeps, 5 seconds silence, repeated once	Normal operation when Test/Reset button is pressed	CO not detected. Alarm for test purposes only
End of unit life indicator	Red LED flashes two times every 30 seconds	Two quick beeps every 30 seconds	End of unit life	Replace unit immediately. Unit will not respond to CO

## 6. Model KN-COPP-B-LP (with digital display) Operating Characteristics









When the unit is first powered up, the green Operate LED flashes once every 30 seconds and the digital display will show three "eights" – indicating the alarm is in the start-up mode. The three "eights" will remain for approximately 30 seconds. Then, the alarm will display "0" and begin monitoring the air for CO and will continue to do so as long as it receives power.

This alarm will display a "0" if CO concentrations between 0 and 30 PPM have been detected within the last 15 seconds.

## 6. Model KN-COPP-B-LP (with digital display) Operating Characteristics

The following table illustrates the possible digital displays, describes the audible alarm patterns, and the recommended actions to take.

### Operating and Alarm Characteristics

LCD Display Shows	Alarm Sound	Unit Status	Recommendation
 A steady display of CO concentration from 30-999. Red LED flashes with beep	4 quick beeps, 5 secs. silence, repeating	Alarm condition. Dangerous concentrations of CO detected	Refer to "What to do When the Alarm Sounds" (inside front cover)
 Brief "888" for approximately 30 seconds	None	Self test when first powered up	None – CO has not been detected. Numbers shown for test purpose only
 Three "---" and then "888"	4 quick beeps, 5 seconds silence, repeated once	Test/Reset button is pressed	None – CO has not been detected. Numbers shown for test purpose only
 Steady "0" displayed, dot flashing every 5 seconds, Green LED flashes every 30 secs.	None	Normal DC operation with good batteries (sensing no CO)	None
 "Lb" flashes alternately with any number, Red LED flashes every 60 seconds.	One quick beep every 60 seconds	Batteries need to be replaced	Replace all three AA batteries immediately
 "Err" displayed	One quick beep every 30 seconds	Unit is in error condition	Replace battery. If "Err" continues, unit has malfunctioned and must be replaced immediately. Unit will not respond to CO. Press the Peak Level button while unit is in "Err" mode to obtain error code and call Product Support line.
 Display is blank	Constant alarm	Unit malfunction	
 Number from 11-999 displayed.	None	Peak Level Memory activated. Highest concentration of CO detected is displayed	Refer to following section for information regarding Peak Level Memory
 "End" displayed. Red LED flashes two times every 30 seconds	Two quick beeps every 30 seconds	End of unit life	Replace unit immediately. Unit will not respond to CO.

The problems listed above are under normal operating conditions. Other "Err" conditions could exist. If you should have any questions regarding display conditions, call our Product Support line.

## 6. Model KN-COPP-B-LP (with digital display) Operating Characteristics

### Peak Level Memory (model KN-COPP-B-LP only)

When the Peak Level button is pressed and held, the display shows the highest CO reading taken by the CO alarm since its last reset or power up. In this example 120 PPM was the maximum amount of CO recorded since the unit was last reset.



**Sample Peak  
Level Reading**

The Peak Level display feature will display levels between 11-999 PPM. Although the Peak Level feature will display levels below 30 PPM, these levels will not result in an alarm no matter how long the device is exposed to these levels. The Peak Level feature is helpful in identifying if you have had a CO reading since resetting the alarm.

Concentrations of CO between 1 and 30 PPM can often occur in normal, everyday conditions. Concentrations of CO below 30 PPM may be an indication of a transient condition that may appear today and never reappear. Some CO conditions may start out as low level leaks but could develop into CO concentrations that may become harmful.

If this happens, the CO alarm will detect the dangerous level and alarm, notifying you and others of the conditions. ***DO NOT ignore high concentration readings above 30 PPM or a CO alarming device that is in alarm.***

### Peak Level Memory Reset

Press the Peak Level button; with the button still pressed, press the Test/Reset button for two seconds and release. The number on the display will turn to "0", the memory will be cleared and the alarm will begin monitoring for CO. The Peak Level memory is also reset when the unit loses power.



## 7. Alarm Characteristics

### Carbon Monoxide Alarm Indicator

When the alarm senses a dangerous level of CO, the unit will emit a loud alarm pattern. The alarm pattern is 4 quick beeps followed by 5 seconds of silence, repeating for as long as dangerous conditions exist. The red Alarm LED will flash the same pattern and the digital display (where equipped) will indicate CO concentrations in parts per million (PPM).

## 8. Maintenance

**NOTE:** This unit is sealed. The cover is not removable.

**Due to the loudness of the alarm, we suggest that you place your fingers over the sounder opening while testing your alarm.**

**Caution: Continuous exposure to the high sound level of this alarm over an extended period of time may cause hearing loss.**

### Testing

To test the alarm, press the Test/Reset button. If the unit is operating properly, you will hear 4 quick beeps – followed by 5 seconds of silence – followed by 4 quick beeps. **(For model KN-COPP-B-LP with digital display: The display will show three "---" and then show "888".)** The red LED will flash along with the beeps. Within several seconds the unit will return to monitor for CO.

**Note: You do not need to press the Test button to take a CO reading.**

### Maintenance Tips

To keep your alarm in good working order, you must follow these steps:

- Test the alarm once a week by pressing the Test/Reset button.
- Vacuum the alarm cover once a month to remove accumulated dust.
- Never use detergents or solvents to clean the alarm. Chemicals can permanently damage or temporarily contaminate the sensor.
- Avoid spraying air fresheners, hair spray, paint or other aerosols near the alarm.
- Do not paint the unit. Paint will seal the vents and interfere with

## 8. Maintenance

proper sensor operation.

Move the CO Alarm to a remote location, to prevent possible damage or contamination of the sensor, prior to performing any of the following:

- Staining or stripping floors or furniture, painting or wall-papering,
-  Using aerosols or adhesives

**WARNING: Reinstall the CO Alarm as soon as possible to assure continuous protection.**

The following is a list of substances that at high levels can damage the sensor or cause temporary readings that are not CO readings:

- Ethylene, ethanol, alcohol, iso-propanol, benzene, toluene, ethyl acetate, hydrogen, hydrogen sulfide and sulfur dioxide.
- Also most aerosol sprays, alcohol based products, paint, thinner, solvent, adhesive, hair spray, after shave, perfume, auto exhaust (cold start) and some cleaning agents.

### FCC COMPLIANCE STATEMENT

This equipment has been tested and found to comply with the limits for a Class B digital device, pursuant to part 15 of the FCC Rules. These limits are designed to provide reasonable protection against harmful interference in a residential installation. This equipment generates, uses and can radiate radio frequency energy and, if not installed and used in accordance with the instructions, may cause harmful interference to radio communications. However, there is no guarantee that interference will not occur in a particular installation. If this equipment does cause harmful interference to radio or television reception, which can be determined by turning the equipment off and on, the user is encouraged to try to correct the interference by one or more of the following measures:

- Reorient or relocate the receiving antenna.
- Increase the separation between the equipment and receiver.
- Connect the equipment into an outlet on a circuit different from that to which the receiver is connected.
- Consult the dealer or an experienced radio/TV technician for help

## TEN YEAR LIMITED WARRANTY

**Warranty Coverage:** The manufacturer warrants to the original consumer purchaser, that this product (except battery) will be free of defects in material and workmanship for a period of ten (10) years from date of purchase. The manufacturer's liability hereunder is limited to replacement of the product, repair of the product or replacement of the product with repaired product at the discretion of the manufacturer. This warranty is void if the product has been damaged by accident, unreasonable use, neglect, tampering or other causes not arising from defects in material or workmanship. This warranty extends to the original consumer purchaser of the product only.

**Warranty Disclaimers:** Any implied warranties arising out of this sale, including but not limited to the implied warranties of description, merchantability and fitness for a particular purpose, are limited in duration to the above warranty period. In no event shall the Manufacturer be liable for loss of use of this product or for any indirect, special, incidental or consequential damages, or costs, or expenses incurred by the consumer or any other user of this product, whether due to a breach of contract, negligence, strict liability in tort or otherwise. The Manufacturer shall have no liability for any personal injury, property damage or any special, incidental, contingent or consequential damage of any kind resulting from gas leakage, fire or explosion. Some states do not allow limitations on how long an implied warranty lasts, so the above limitation may not apply to you. Some states do not allow the exclusion or limitation of consequential or incidental damages, so the above limitations or exclusions may not apply to you.

**Legal Remedies:** This warranty gives you specific legal rights and you may also have other rights that vary from state to state.

**Warranty Performance:** During the above warranty period, your product will be replaced with a comparable product if the defective product is returned in a postage paid package to the following address: Kidde, Customer Service Department, 1016 Corporate Park Drive, Mebane, NC 27302 USA, together with proof of purchase date. Please include a note describing the problem when you return the unit. The replacement product will be in warranty for the remainder of the original warranty period or for six months, whichever is longer. Other than the cost of postage, no charge will be made for replacement of the defective product. In many cases the quickest way to exchange your alarm is to return it to the original place of purchase. If you have questions, call Kidde customer service department.

**IMPORTANT: Do not remove unit back cover. Back cover removal will void warranty.**

Your Kidde Carbon Monoxide Alarm is not a substitute for property, disability, life or other insurance of any kind. Appropriate insurance coverage is your responsibility. Consult your insurance agent.

Also, Kidde makes no warranty, express or implied, written or oral, including that of merchantability or fitness for any particular purpose, with respect to the battery.

The above warranty may not be altered except in writing signed by both parties hereto.

### QUESTIONS OR FOR MORE INFORMATION

Call our Product Support line at **1-800-880-6788** or contact us at our website at **[www.kidde.com](http://www.kidde.com)**



Kidde, 1016 Corporate Park Drive, Mebane, NC 27302