



Meaco 10L small home dehumidifier Instruction Manual



Please read this instruction manual before using the dehumidifier and keep safe for future reference.

Extend your warranty on page 13

PRODUCT DESCRIPTION

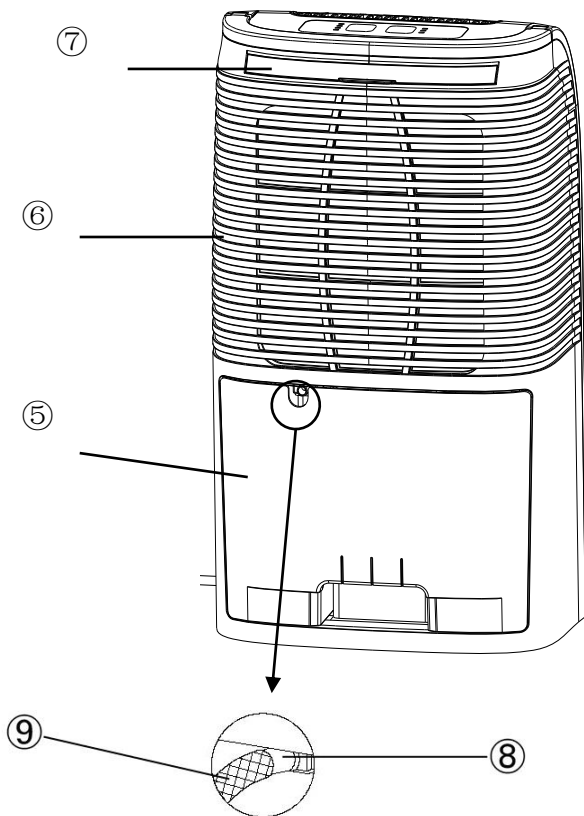
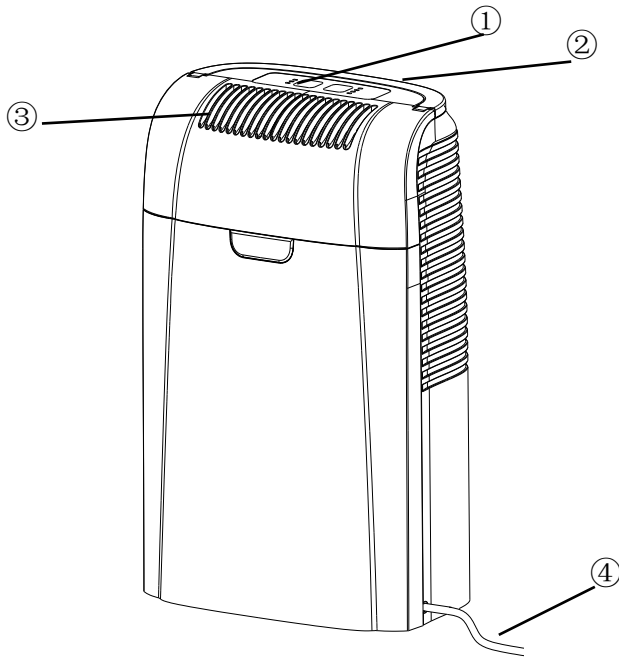



Main Parts

- ① Control panel
- ② Handle
- ③ Dried air outlet
- ④ Mains cord
- ⑤ Water container
- ⑥ Air inlet
- ⑦ Air filter
- ⑧ Drain spout
- ⑨ Drainage tube

SAFETY INSTRUCTIONS

PLEASE READ ALL INSTRUCTIONS CAREFULLY BEFORE OPERATING.

WARNING - This appliance is intended for use in a domestic environment only. Any other use is not recommended by the manufacturer and may cause fire, electrical shocks or other injury to person or property. When using electrical appliances, basic safety precautions should always be followed:

1. Do not operate the unit with a damaged cord or plug, after it malfunctions or has been dropped or damaged in any way. Return to an authorized service facility for examination and repair.
2. This unit should always be kept in an upright position to avoid any damage. Locate the unit on a flat stable surface.
3. Check the household voltage to ensure it matches the units rated specification before operating.
4. Operate this unit in an ambient temperature between 5°C and 40°C.
5. Ensure that the air inlets and outlets are not blocked or covered.
6. Do not place the unit too close to curtains or other objects - min 40cm.
7. When using the "LAUNDRY MODE"  to speed up the drying of wet clothes in the room, keep the clothing at a safe distance from the unit to prevent water from dropping onto the unit.
8. Never place anything on top of the unit and do not cover with any kind of material while in use.
9. This product is intended for domestic and light office use ONLY and not for commercial, industrial or outdoor use.
10. To protect against electrical shocks, do not immerse unit, plug or cord in water, or spray with liquids.
11. Never unplug the power cord without press the "ON/OFF"  key to off first, as this could damage the unit.
12. Always unplug the unit when not in use or moving location. To disconnect from the power supply, grip the plug and pull from the power socket. Never pull by the cord.
13. Always empty the water tank before storing the unit away.
14. Close supervision is necessary when any appliance is used by or near children and pets.
15. Do not run power cord under carpeting, or cover with rugs or runners. Arrange the cord away from areas where it may be tripped over.
16. Never operate or store the unit in direct sunlight.
17. To repair the unit, take it to a qualified service engineer. Repairs carried out by unqualified people may cause damage to the unit or injury to persons or property and void the warranty.
18. Where possible, avoid the use of an extension cable as they may overheat and cause a risk of fire. Only use an extension cord after ensuring it is in perfect condition.
19. Do not use the unit without the air filter as this will allow dirt to gather inside the dehumidifier and could invalidate the warranty.
20. Check the filter regularly in order to keep it clean as per page 10. A dirty filter will restrict the air flow into the machine which will increase the resistance on the fan and could result in damage and might invalidate the warranty.

PLEASE READ AND SAVE THESE IMPORTANT SAFETY INSTRUCTIONS

BS PLUG WIRING

Wiring Instructions: Should it be necessary to change the plug please note the wires in the mains lead are coloured in accordance with the following code :

BLUE - NEUTRAL

BROWN - LIVE

GREEN AND YELLOW – EARTH

As the colours of the wires in the mains lead of this appliance may not correspond with the coloured markings identifying the terminals in your plug, proceed as follows:

1. The **BLUE** wire is the **NEUTRAL** and must be connected to the terminal which is marked with the letter **N** or coloured **BLACK**.
2. The **BROWN** wire is the **LIVE** and must be connected to the terminal which is marked with the letter **L** or coloured **RED**.
3. The **GREEN/YELLOW** is the **EARTH** and must be connected to the terminal which is marked with the letter **E** or or coloured **GREEN OR GREEN/YELLOW**.
4. Always ensure that the cord grip is positioned and fastened correctly.

If a 5A (BS 1363) fused plug is used it must be fitted with a 5A fuse. If in doubt consult a qualified electrician.

Wiring for a 5Amp Plug (BS1363)

Please note. The Earth Terminal is marked with the letter **E** or Earth Symbol.

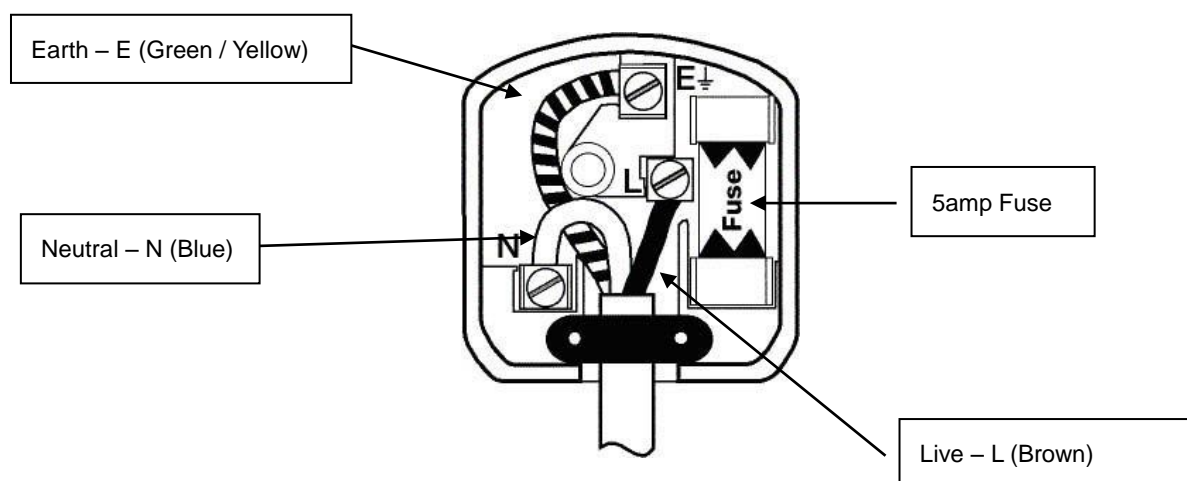



THE CONTROL PANEL





-  - Lights up when there is power to the dehumidifier

-  - Lights up when the internal tank is full of water and needs to be emptied or when the tank is incorrectly fitted.

-  - Lights up when the dehumidifier is deicing. This is more common when the dehumidifier is being used below 16°C, the dehumidifier will stop drying for about 10 minutes whilst it defrosts and will then dehumidify for the next 40 minutes before defrosting again.

-  - Press the Mode button to toggle between the following settings.

-  - Use this mode when you want to dry washing. For optimum performance place the dehumidifier in as small a room as possible with the door and windows closed. The dehumidifier will dry continuously to try to achieve a relative humidity of about 40%rh which will help to dry the washing efficiently. Take care to ensure that the dehumidifier does not become covered by the washing and that no water drips onto the dehumidifier.

-  - Runs the dehumidifier until a relative humidity of 40%rh is achieved and then switches the unit off.

-  - Aims to achieve a relative humidity of 60%rh which will be fine for most household applications. To prevent condensation on single glazed windows or when the outside temperature drops below about 5°C you should use Maximum instead of Normal.

-  - Not recommended for the majority of applications as it only controls the relative humidity to 80%rh and this is not enough to prevent condensation or the build-up of mould.

UNDERSTANDING AND USING A DEHUMIDIFIER

How does a dehumidifier work?

There are four types of dehumidifier sold to the domestic market in the UK - compressor (this dehumidifier), desiccant, peltier and silica gel.

A compressor based dehumidifier draws the air in from the room over a filter and passes it over some cold coils similar to the coils on a fridge. As the coils are cold, water condenses and drips into a bucket. The air is then reheated to room temperature and blown back out of the dehumidifier.

Why does water appear on my windows/cupboards/walls?

It is a basic law of physics that if the surface is cold enough and if there is enough water vapour in the air then it will condense. This means in the case of windows whether they are double-glazed or not that if the windows are cold enough and there is enough moisture in the air then condensation will occur.

Where does this water come from?

We all produce water by drying clothes indoors, the boiling of vegetables, showering, rain, calor gas heating, breathing(!) and making cups of tea all produces moisture. It is just an on-going process that never stops.

Can I just get rid of it by opening my windows?

This is fine on a nice summer's day but in winter opening your windows will just result in you losing the heat from your central heating and creating draughts. This is a waste of money and if it is raining will just let more moisture in. You might as well just throw fivers out of the window.

Will a dehumidifier do the whole house?

A dehumidifier creates a volume of dry air in as large a space as its fan can effect (this dehumidifier can control up to a small 3 bedroom house). After that it will be helped by the fact that damp air will always migrate to dry places. As long as you leave all of the internal doors open a correctly sized dehumidifier will prevent condensation and mould from appearing around the whole house.

What about the black spots of mould on my window and bathroom sealant?

Mould occurs around 68% humidity, condensation occurs at 100%. As you can see from this you can have mould but still have clear windows. A dehumidifier will prevent the mould from getting any worse and once you have cleaned the mould away, it will stop it from coming back.

Do I put it in the worst room?

You can if you like put it in the main problem area to start with and then move it somewhere more convenient when you feel that the problem is under control. If it is just condensation on the windows that you are worried about a dehumidifier in a central position, for example the bottom of the stairs, will cure the problem in the whole house.

UNDERSTANDING AND USING A DEHUMIDIFIER

Are they expensive to run?

A compressor based dehumidifier costs about 2-3p(ish) an hour to run. You should take into consideration the fact that the dehumidifier will not run all the time, as it will be controlled via its humidistat. Secondly it is very expensive to heat a damp house and you will see a reduction in your central heating bill when you start to use your dehumidifier. The dehumidifier will work hard for the first month or so as it dries the house out and then it will spend longer turned off as it starts to settle down.

What is the humidistat?

Just as you have a thermostat that you set on your central heating you have a humidistat on your dehumidifier. This will allow the dehumidifier to turn off and on as required without you having to worry about it.





Should I turn the dehumidifier on for just a few hours a day?

No just let the dehumidifier's humidistat decide when to come on. Running a dehumidifier for just a few hours a day is a real false economy. The more water you let the dehumidifier collect, the dryer the home will be and the more money you will save on heating the house.

Will they help with allergies?

A dehumidifier will reduce the relative humidity in the house, which will prevent dust mites and other pests from breeding. Mould spores will not be produced because the relative humidity will be lower. As dust mites and mould spores are two of the main triggers of allergies in this way a dehumidifier can help with allergies.



DEHUMIDIFIER SETUP AND USE

- Place the dehumidifier in an upright position on a stable, flat surface.
- Please ensure the unit is a safe distance away from a wall or furniture.
- Please keep clothes at a safe distance of 40cm away from the air inlet or outlet to prevent water from dripping into the unit.
- Ensure the tank is correctly fitted, if the tank is full or is not in place, the “Empty Tank”  light comes on, an alarm will sound and the dehumidifier will turn off.
- Press the On/Off  button, you should hear three beeps.
- Select the Mode that you want to use the dehumidifier in, for most applications this will be the “Normal”    mode. For more detail refer to page five.
- To turn off press the on/Off button again.

Where to position the dehumidifier

- For best results position the dehumidifier somewhere central like a landing or a hallway. As long as the internal doors are open the moisture will migrate naturally towards the dehumidifier to be processed.
- To dry washing it is best to put the dehumidifier into a small room with some heating on. Close the door and windows and use the dehumidifier in “Laundry”  mode. Hang the clothes so that they are not touching each other and so that air can circulate between the clothes. Ensure that water does not drip onto the dehumidifier.

Amount of water collected

- When you first use your dehumidifier it will work harder to reduce the room humidity down to 60%rh (in “Normal”  mode). This is the time when it will produce the most water and need emptying most frequently. As the room becomes dryer the dehumidifier collects less water and takes longer to fill the tank, this is perfectly normal. When the target relative humidity has been reached the dehumidifier will stop collecting water, again this is normal.
- If you find that you still have condensation on your windows or you need to dry the air further then use the “Maximum”  mode. This might well be necessary if you have single glazed windows or if the outside air temperature drops towards freezing.

To operate safely

- Do not insert small objects into the unit or this will damage it and cause a hazard.
- Do not remove the tank when the dehumidifier is running or water may leak.
- Minimum operating condition 5°C at 50%rh relative humidity.



ATTENTION !

- Never use the device with a damaged power cord, plug, cabinet or control panel. Never trap the power cord or allow it to come into contact with sharp edges.
- Failing to follow the instructions may lead to the guarantee becoming void.

EMPTYING THE WATER

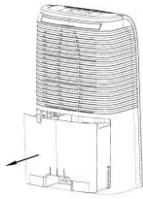

When the water tank is full  :

- An alarm signal will sound
- The dehumidifier will stop automatically.
- Empty the water tank and replace it in the correct position. The dehumidifier will start to work again and the compressor will start up after three minutes.

If the "Empty tank"  light stays on and the unit does not start up then the tank is not correctly fitted.

Continuous Drainage

It is possible to connect the drainage hose (included in the box) to the dehumidifier for permanent water drainage. Simply connect the hose to the drain spout and ensure that the end of the hose is lower than the drain opening, otherwise the water will not drain and flooding may occur.

Place the end of the drainage hose on the water outlet. 

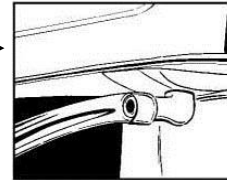

When you no longer wish to use the permanent water drainage, disconnect the drainage tube from the device. Ensure that the water container is positioned correctly.

CLEANING

Switch the dehumidifier off and remove the plug from the socket before cleaning.

The exterior

Clean the exterior with a soft, dry cloth. If the device is extremely dirty, use a mild cleaning agent. Wipe the dehumidifier with a slightly damp cloth. Never spray the device with water.

The air filter

When used regularly, the filter may become clogged with dust and particles. Therefore the filter should be cleaned at least every two weeks. Follow these steps:

1. Remove the filter.

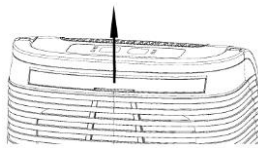

2. Clean the filter with a vacuum cleaner or with water. Dry the filter and replace it. Ensure that the filter is completely dry.



Never use the device without the air filter.

Storage

If the machine will not be used for a long period of time, take the following steps:

1. Remove the plug from the socket and empty the container. Allow the container and the dehumidifier to dry completely.
2. Clean the air filter.
3. Store the device in a dust-free location away from direct sunlight, preferably covered with a sheet of plastic.

TROUBLESHOOTING

Check the following before contacting technical support:

Problem	Cause	Solution
The unit does not work.	The power is not connected.	Insert the plug into the wall outlet.
The device does not dehumidify.	The water container is full.	Remove the water from the container.
	The water container has not been replaced correctly.	Place the water container in the correct position.
	The air filter is clogged.	Clean the air filter.
	The temperature or relative humidity in the room where the device is operating is too low.	It is normal that the device does not dehumidify in these conditions.
The dehumidifier works, but reduces the relative humidity insufficiently/there is little water in the water tank.	The house is too large. This dehumidifier can dry up to about a small three bedroom house.	We recommend using a dehumidifier with a greater capacity.
	There are too many sources of moisture. Bathing, washing, drying clothes and cooking all puts moisture into the air. Calor gas heating can add too much moisture into the air for a dehumidifier.	We recommend using a dehumidifier with a greater capacity. Consider using a different heat source to a calor gas heater.
	There is too much ventilation.	Reduce ventilation (e.g. close windows and shut doors.)
	The air filter is blocked and the reduce air flow is effecting performance.	Clean the air filter.
The windows were clear and now condensation has returned.	The outside air temperature has dropped and the windows are colder.	Use the dehumidifier on Maximum and run it 24 hours a day.
I cannot remove the condensation from my windows, even in Maximum mode.	The surface temperature of the windows is too low for a dehumidifier to prevent condensation. Common with single glazed windows and when the outside air temperature drops below freezing.	Keep running the dehumidifier on Maximum 24 hours a day and when the air temperature outside increases the windows should clear of condensation.
Dehumidifier is blowing out warm air.	The dried air is past over heating coils before it is blown into the room as part of the dehumidification process.	This is normal, a dehumidifier is not an air cooler.
The dehumidifier is noisy.	The air filter is blocked or the unit is on an uneven surface.	Clean the filter and or put the dehumidifier on a flat surface. A dehumidifier will also be noisier on wooden floors than on carpet.
Defrost light is on	The temperature is below 16°C	This is normal and the dehumidifier will alternate between dehumidification and defrosting as

		required
Dehumidifier beeps	Temperature is above 40°C/unit is faulty	If the temperature is high or the dehumidifier is standing in front of a radiator then the dehumidifier will not work properly. If high temperature is not the issue then call Meaco for a repair.
No buttons work	Humidity and temperature sensor open circuit.	Call Meaco on 01483 234900 to arrange a repair.

CONDITIONS OF WARRANTY

There is a one year warranty on your dehumidifier from the date of purchase.
All material or manufacturing defects will be repaired free of charge.

The following applies:

- Any repairs or replacement of components during the warranty period will not result in an extension of the warranty period.
- The warranty will expire if any alterations have been made, not genuine components have been fitted or if the dehumidifier has been repaired by a third party.
- Components subject to normal wear and tear, such as the air filter, are not covered by the warranty.
- The warranty is only valid on presentation of the original, unaltered, and date-stamped purchase receipt.
- The warranty does not cover damage caused by actions that deviate from those as described in the user's manual or by neglect.
- All claims for compensation, including consequential damage, will not be entertained.
- The warranty can be invalidated if the dehumidifier is found to be dirty or if the filter or the internals have been clogged.

To prevent unnecessary expenses, we recommend that you always carefully read the user's manual first. If this does not provide a solution, then call Meaco (U.K.) Limited on freecall 0500 418458 or 01483 234900 between Monday to Friday 9am to 5pm.

This appliance is not intended for use by person (including children) with reduced physical, sensory or mental capabilities, or lack of experience and knowledge, unless they have been given supervision or instruction concerning use of the appliance by a person responsible for their safety.

Children should be supervised to ensure that they do not play with the appliance.

You can extend your warranty from the standard one year up to a maximum of five years at any time in the first year of ownership by visiting <http://www.meaco.com/proddetail.asp?prod=Extwarranty>. If you have trouble in using this link then go to www.meaco.com and you will find the extended warranty under Dehumidifiers.

TECHNICAL SPECIFICATIONS

Model	Meaco 10L small home dehumidifier
Power consumption	220 Watts
Power supply	220-240V / 50Hz
Current (nominal)	1.0 A
Dehumidifying capacity	10 litres / day (at 30°C, 80%RH)
Capacity water container	2 litres
Air flow (nominal)	> 88 m ³ / h
For rooms up to	80-120 m ³
Operating range	5 – 35°C
Automatic defrost	Yes
Compressor type	Rotary
Refrigerant type / charge	R134a / 120 g
Dimensions (w x d x h)	296 x 186 x 483 mm
Net weight	8.75kgs
Gross weight	9.52kgs
Sound pressure level	46dB
Unit Protection	IP20 (not for use in a bathroom)
Fuse rating	250V. F1.6A



This marking indicates that this product should not be disposed with other household wastes throughout the EU. To prevent possible harm to the environment or human health from uncontrolled waste disposal, recycle it responsibly to promote the sustainable reuse of material resources. To return your used device, please use the return and collection systems or contact the retailer where the product was purchased. They can take this product for environmental safe recycling.



CUSTOMER SERVICE

Thank you for choosing Meaco, we really appreciate it, this dehumidifier has been imported into the U.K. by;

Meaco (U.K.) Limited
Meaco House
Parklands
Railton Road
Guildford
GU2 9JX

Telephone: 01483 234900/0500 418458
Email: customerservice@meaco.com
Website: www.meaco.com
Fax: 01483 232700

Please record, for future reference, your date of purchase and where you bought the dehumidifier from here.

Date of purchase.....

Purchased from www.meaco.com (if not then please record the supplier's name below).

.....

Meaco are specialists in dehumidifiers and would welcome your comments and questions on this dehumidifier. If you do develop a fault within the first year then please do call us and if we cannot fix the problem over the phone we will be happy to collect the dehumidifier from you at our expense and repair or replace as appropriate.

Please save the box just in case this happens.