



Cordless stick vacuum cleaner; household type

Owner's Guide

Thank you for purchasing your new vacuum!

Important instructions

For easy assembly, please take a few moments to read this owner's guide. If you have questions about your new vacuum, please contact our customer service HELPLINE

We're here to help!

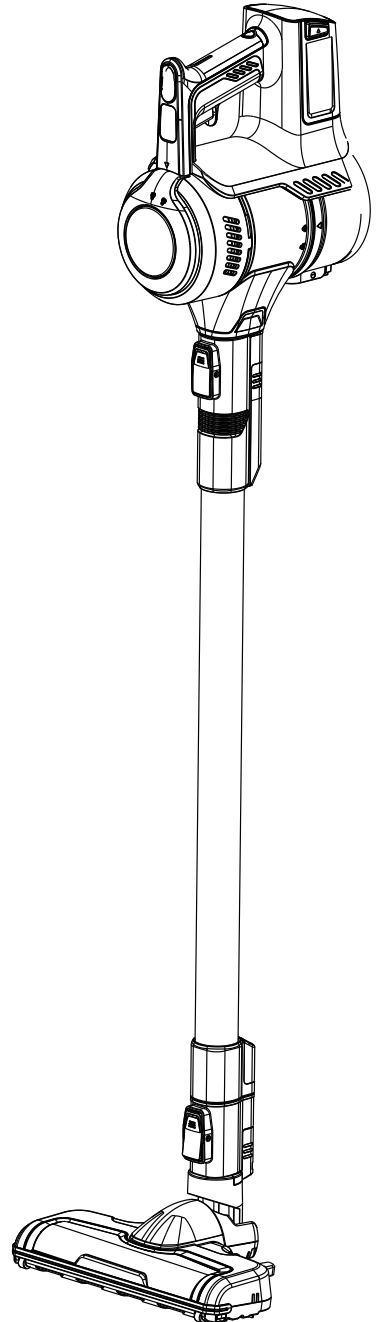

Model: AVXVAC300

Where to find important vacuum information

Keep this information

Write the model, type and serial number here:

Date of purchase (keep your receipt) _____

Model number and type _____

Serial number _____

Find these numbers on a label on the hand vacuum, battery, and charger. Refer to these numbers when ordering parts and accessories, or if service is needed.



This Owner's Guide provides important instructions to prolong the life of your vacuum cleaner

Contents

Important safeguards.	3
What comes in the carton	4
How to identify parts of your vacuum cleaner	5
Easy assembly, How to install wall mount, How to charge battery and Battery indicator lights	6
How to use your vacuum cleaner	7
How to use hand vacuum and accessory tools	7-8
How to maintain your vacuum cleaner	9
How to maintain dust cup, filters and brushroll	9
The limited warranty	10
Thermal cut-off and problem solving	11
How to dispose vacuum cleaner and battery pack	11
How to order replacement parts	12

 Follow caution information wherever you see this symbol.

IMPORTANT SAFEGUARDS

When using an electrical appliance, basic precautions should always be followed, including the following:

READ ALL INSTRUCTIONS BEFORE USING THIS VACUUM CLEANER

Failure to follow the warnings and instructions may result in electric shock, fire and/or serious injury.

WARNING

- Prevent unintentional starting. Ensure the switch is in the off-position before connecting to battery pack, picking up or carrying the appliance. Carrying the appliance with your finger on the switch or energizing appliance that has the switch on invites accidents.
- Do not touch nozzle when the vacuum cleaner is on. Danger.
- Do not put any object into openings. Do not use with any openings blocked; keep free of dust, lint, hair and anything that may reduce air flow.
- Do not use outdoors or on wet surfaces.
- Do not operate the vacuum cleaner or charger if it has been damaged in any way. If vacuum cleaner is not working as it should, has been dropped, damaged, left outdoors, or dropped into water, call the Customer Service **HELPLINE**
- To avoid excessive heat and damage to the unit or battery, the vacuum cleaner will not operate while charging.
- Do not allow to be used as a toy. Close attention is necessary when used by or near children.
- Use only as described in this manual. Use only manufacturer's recommended attachments.
- Recharge only with the charger specified by the manufacturer. A charger that is suitable for one type of battery pack may create a risk of fire when used with another battery pack.
- Do not pull or carry the charger by cord, use cord as a handle, close a door on cord, or pull cord around sharp edges or corners. Do not run appliance over cord. Keep cord away from heated surfaces.
- This charger is not intended for use by travelers.
- Do not use extension cords or outlets with inadequate current-carrying capacity for the charger.
- Do not unplug by pulling on cord. To unplug, grasp the plug, not the cord.
- Do not handle charger or vacuum cleaner with wet hands.
- Use appliances only with specifically designated battery packs. Use of any other battery packs may create a risk of injury and fire.
- **DO NOT MUTILATE OR INCINERATE BATTERIES. THEY BECOME DANGEROUS AT HIGH TEMPERATURES.**
- Liquid ejected from the battery may cause irritation or burns. If the liquid gets on the skin, (1) seek medical attention, (2) wash quickly with soap and water, and (3) neutralize with a mild acid such as lemon juice or vinegar. If the liquid gets into the eyes, flush them immediately with clean water for a minimum of 10 minutes.
- When battery pack is not in use, keep it away from other metal objects, like paper clips, coins, keys, nails, screws or other small metal objects, that can make a connection from one terminal to another. Shorting the battery terminals together may cause burns or a fire.
- This product is functioning at temperature range within 40°F - 104°F.
- Do not use a battery pack or appliance that is damaged or modified. Damaged or modified batteries may exhibit unpredictable behavior resulting in fire, explosion or risk of injury.
- Do not expose a battery pack or appliance to fire or excessive temperature. Exposure to fire or temperature above 266°F may cause explosion.
- Follow all charging instructions and do not charge the battery pack or appliance outside of the temperature range specified in the instructions. Charging improperly or at temperatures outside of the specified range may damage the battery and increase the risk of fire.
- Have servicing performed by a qualified repair person using only identical replacement parts. This will ensure that the safety of the product is maintained.
- Do not modify or attempt to repair the appliance or the battery pack except as indicated in the instructions for use and care.
- The terminals on both the vacuum cleaner and battery should be kept free and clean of objects. Do not insert metal objects inside the terminals.
- This vacuum cleaner creates suction. Keep hair, loose clothing, fingers, and all parts of body away from openings and moving parts.
- Do not pick up anything that is burning or smoking, such as cigarettes, matches, or hot ashes.
- Do not use without filters in place.
- Use extra care when cleaning stairs.
- Do not use to pick up flammable or combustible liquids, such as gasoline, or use in areas where they may be present.
- Store vacuum cleaner and charger indoors in a cool, dry area. To avoid electric shock and/or cleaner damage, do not expose to weather elements.
- Keep your work area well lit. Unplug electrical appliances before vacuuming them.
- Overcharging, short circuiting, reverse charging, mutilating or incinerating the cells and the batteries must be avoided.
- If a cell or a battery has leaked or vented, it should be replaced immediately using protective gloves.
- If and when necessary, these cells or batteries must be replaced with identical new ones from the same manufacturer. If a cell or a battery to be replaced is connected with other cells or batteries in series, it is recommended that the other cells or batteries be replaced with new ones at the same time.
- Reverse polarity installation of the cell or the battery in the end product must be avoided.
- Do not incinerate this appliance even if it is severely damaged. Contact local waste facility before discarding in trash.
- **WARNING:** This product can expose you to chemicals including Bis-(2-ethylhexyl) phthalate, which are known to the State of California to cause cancer and to cause birth defects or other reproductive harm.

SAVE THESE INSTRUCTIONS

What comes in the carton

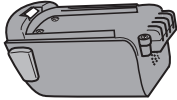

Battery

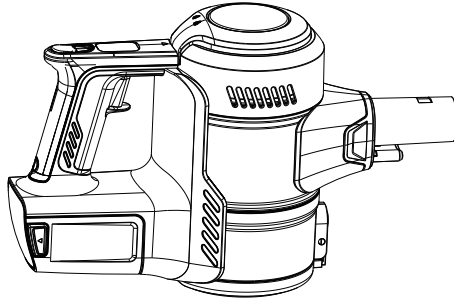

Hand vacuum

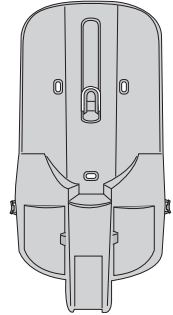

Wall mount

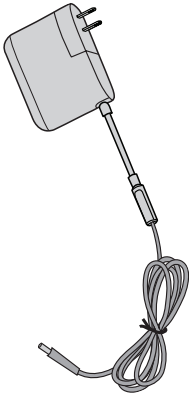

Charger



Important safeguards

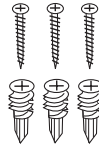

3 screws & drywall anchors



Wand

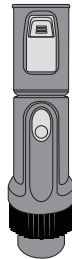

2-in-1 upholstery tool

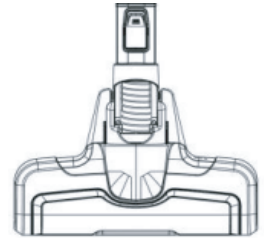

Motorized floor nozzle

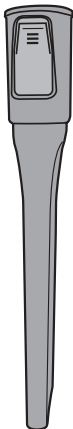

Crevice tool

How to identify parts of your vacuum cleaner

Cordless vacuum cleaner

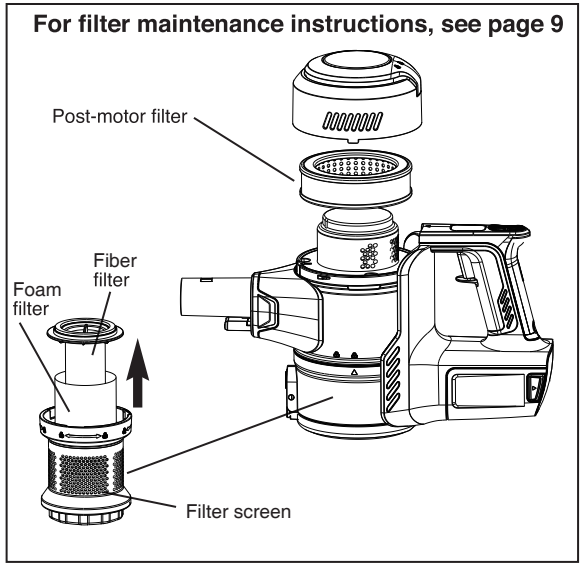
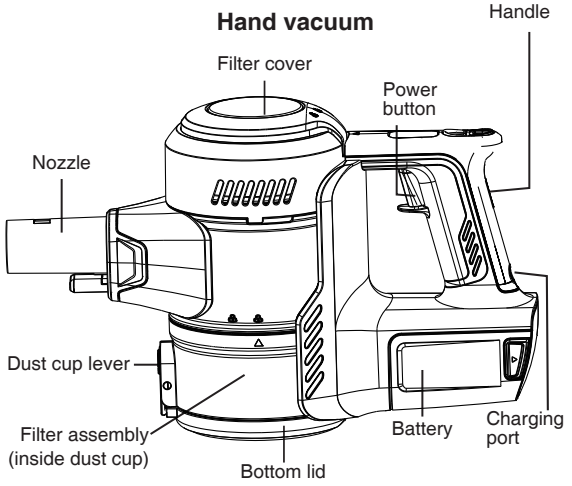
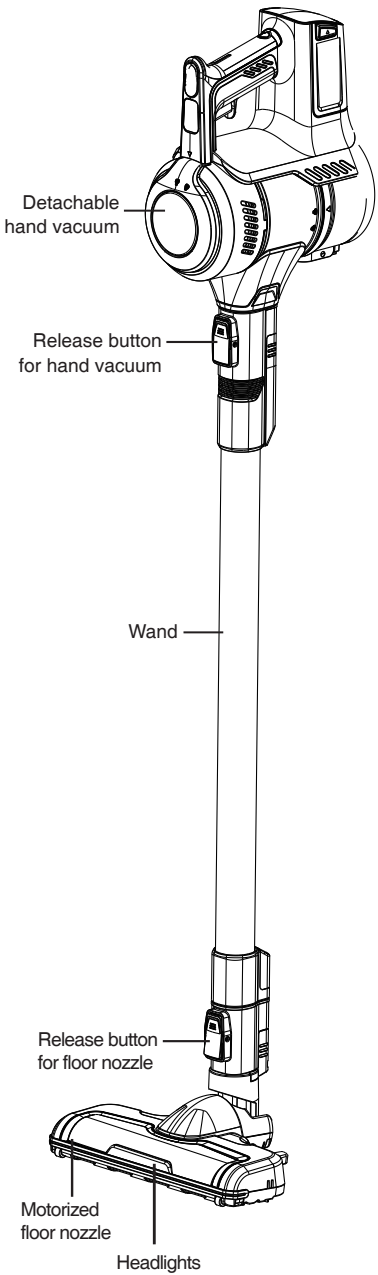

Easy assembly

1. Slide battery onto hand vacuum until firmly attached (Fig. 1).
2. Slide wand onto hand vacuum until it clicks (Fig. 2).
3. Push wand into motorized floor nozzle until it clicks (Fig. 3).

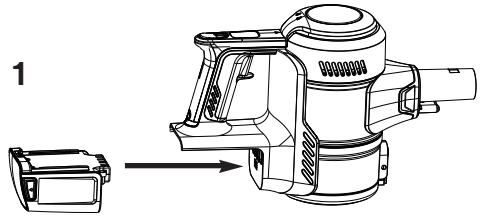

How to install wall mount

- Choose location near power outlet. Locate point high enough on wall to allow wand and motorized floor nozzle to hang freely.
- Place mount against wall and use pencil to mark drill holes.
- Drill holes (with 1/4" bit) and insert drywall anchors. Insert screws through holes on mount and tighten until firmly attached (Fig. 4).

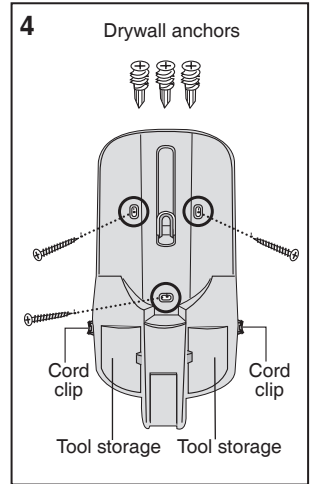
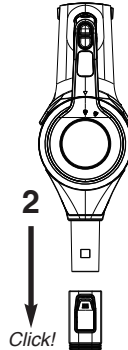

How to charge battery and store accessories (Fig. 5)

- Place assembled vacuum cleaner on wall mount.
- Plug charger into power outlet and then into charger port on hand vac.
- Loop charger cord into clips on sides of wall mount.
- Snap tool(s) into tool storage areas.

Battery indicator lights show level of charge (Fig. 5)

- Indicator lights stop blinking when fully charged.
- Charge battery fully before using for the first time. This may take up to four hours.

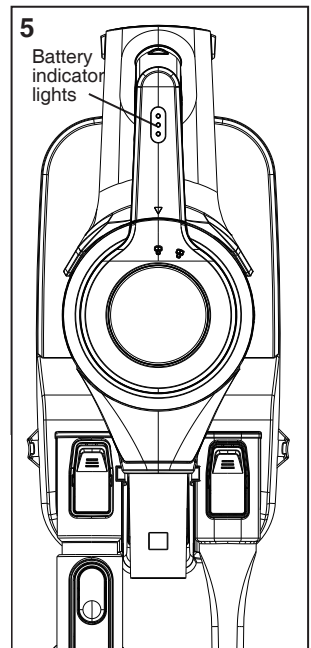
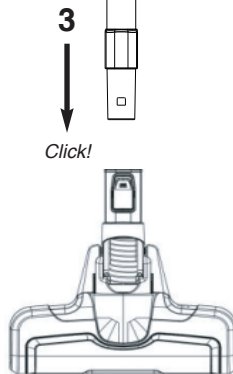

How to use cleaner for cleaning floors

1. Click power button once to start (Fig. 1).
2. Select carpet or floor depending on what type of surface you are cleaning (Fig. 2).
3. For maximum power, press the MAX power button (Fig. 2).
4. Using motorized floor nozzle, glide back and forth on area to be cleaned. Avoid oversized or sharp items (such as screws) with cleaner.
5. Twist wrist to engage swivel function (Fig. 3).
6. When done, click power button once to stop motor.

1 Power button

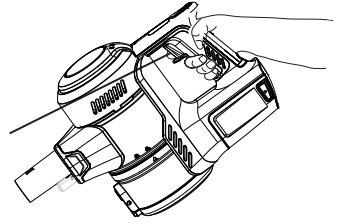

2 Hard floor/carpet button

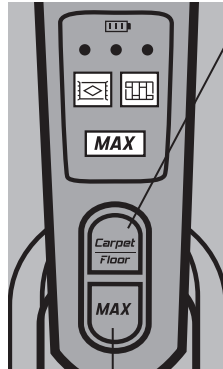

MAX power button

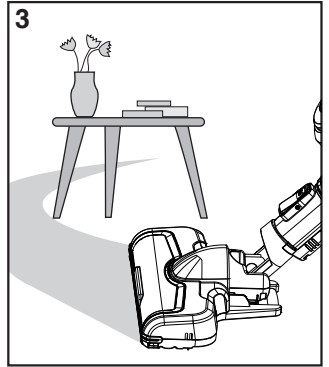

This cleaner has a unique swivel feature that allows for easy maneuvering around furniture. Twist wrist to engage swivel function.

Empty dust cup after every use

There are two ways to empty the dust cup:

1. Hold cleaner over waste basket. Press lever to release bottom lid of dust cup to empty debris (Fig. 4).
2. Or, remove dust cup from hand vacuum by twisting to 'unlock' position (Fig. 5). Once emptied, reattach dust cup by lining up arrow ▲ and 'unlock' position. Twist dust cup until arrow ▲ lines up with 'locked' position.

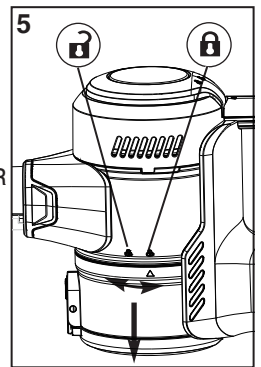
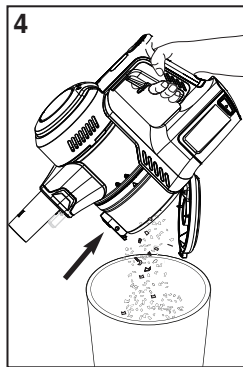

OR

How to use hand vacuum and accessories

CAUTION
Moving parts! Always turn off hand vacuum before attaching accessories.

The hand vacuum can be used with or without tools.

- To use without tools, press release button and remove wand. Collect debris directly with hand vacuum nozzle (Fig. 1).
- To use tools with wand, press release button to remove motorized floor nozzle. Slide tool onto end of wand until it clicks (Fig. 2).
- To use tools with hand vacuum only, press release button to remove wand. Slide tool onto hand vacuum until it clicks (Fig. 3).
- Note when using the hand vacuum, the carpet and hard floor selectors will not be available. MAX mode will still be available.

How to use hand vacuum and motorized floor nozzle

Ideal for cleaning stairs.

- Press release button to remove wand from hand vacuum. Attach motorized floor nozzle directly to hand vacuum until it clicks.
- Click power button once to start.

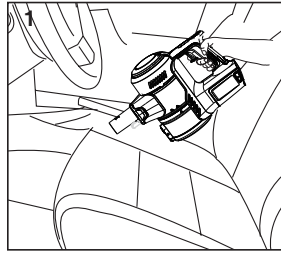
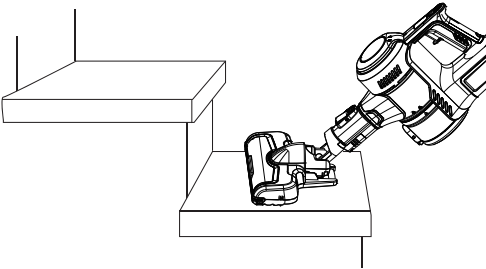

Crevice tool: Cleans hard-to-reach areas such as corners, baseboard edges, dryer vents, chairs and sofas.



2-in-1 upholstery tool: Use brush to vacuum blinds, vents or upholstered surfaces. Use felt portion to clean delicate surfaces.

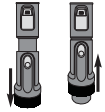
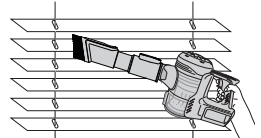

To switch between felt and brush portions, press thumb release and slide brush up or down.

How to maintain your vacuum cleaner

⚠ CAUTION

WARNING: Moving parts!
Recharge cleaner after each use.

Never operate vacuum cleaner without all filters, filter screen and dust cup in proper position.

Washable dust cup filter - clean frequently

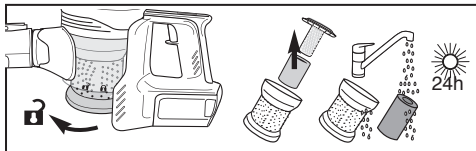

1. Twist dust cup and remove.
2. Twist filter screen and remove.
3. Lift out foam filter and holder.
4. Separate foam filter from fiber filter by pulling them apart.
5. Rinse and dry **THOROUGHLY**.
6. Reassemble once completely dry.

Washable post-motor filter – clean every 6 months

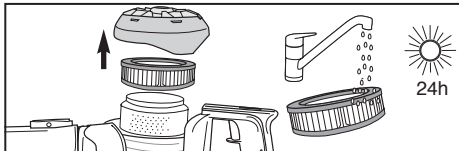

1. Twist filter cover and remove.
2. Lift out post-motor filter.
3. Shake to remove dust.
4. Every 6 months, replace filter or rinse and dry **THOROUGHLY**.
5. Reposition filter and cover and twist to 'lock.'

Brushroll maintenance - clean frequently or when brushroll indicator light turns red

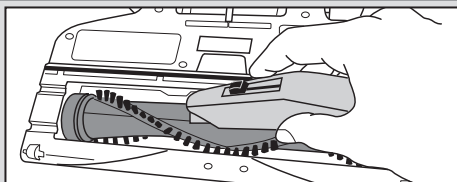

Place motorized floor nozzle upside down. Use scissors or knife to cut strings and threads.

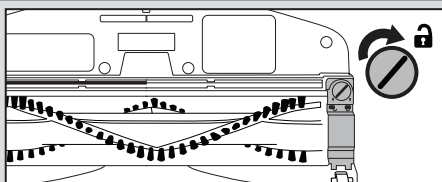

If debris cannot be removed easily, remove retainer clip to access brushroll. Using flathead screwdriver or coin, turn screw to the 'unlock' position.

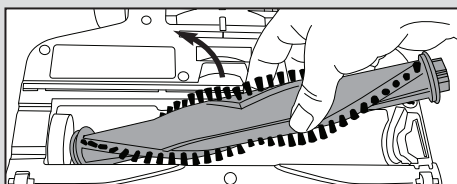

Remove retainer clip and lift out brushroll to clean and remove debris.

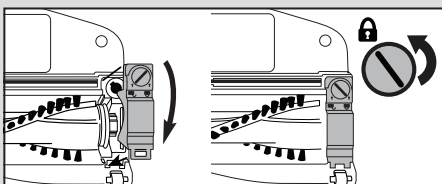

To reassemble:

1. Align one end of brushroll with floor nozzle gear.
2. Press other end into slot.
3. Hook retainer clip under tab and press down.
4. Insert screw and turn to 'lock' position.

The two-year limited warranty

Smart Life Corp. ("Bluebot"), subject to the terms and conditions herein, warrants this vacuum cleaner to be free from defects in material and workmanship for a term of two years from the date of original purchase when used in accordance with the Smart Life operating and maintenance instructions and under normal household usage. This warranty is granted only to the original purchaser and members of immediate household, and is applicable only to original purchases from Smart Life authorized resellers.

What we will do:

We will, at its option, repair or replace a defective vacuum or vacuum part that is covered by this warranty. Repairs may be performed using new or refurbished parts that meet or exceed Smart Life specifications for new parts. If Smart Life selects to replace the vacuum, the replacement may be a reconditioned unit. Depending on availability of products, Smart Life reserves the right to provide you with a replacement product that is the same or similar, or substitute equivalent of the original product. As a matter of warranty policy, Smart Life will not refund the consumer's purchase price.

This warranty does not cover:

- Battery module and battery components. The battery module and its components are covered by a separate one-year limited battery warranty.
- Normal wear and tear of the vacuum and vacuum parts that require replacement under normal use such as disposable dust bags, filters, drive belts, light bulbs, brush-roll, bristles, impellers and cleaning.
- Damages or malfunctions resulting from: improper or unreasonable use or maintenance, abuse, negligence, failure to follow instructions contained in any written materials that accompany the product, deterioration by reason of excess moisture, corrosive atmosphere, lightning, power surges, connections to improper voltage supply, unauthorized alteration, or other external causes such as extremes in temperature or humidity, modifications, scratches or discoloration, accidents, misuse, or acts of God. This warranty also does not cover damage resulting from repair or attempted repair by anyone other than Smart Life or an authorized Smart Life Warranty Station. This warranty is not applicable to any product that has been altered or on which the serial number has been defaced, modified or removed. Altering, erasing, or forging any proof-of-purchase documents voids any applicable product warranty.

Obtaining warranty service:

To obtain warranty service you must contact the Smart Life Team, toll free, at 31-6208-88865, to discuss the the warranty claim and procedures to be followed. All warranty claims must include submission of proof-of-purchase documentation. For additional information, you may also visit our website.

Shipping charges:

You will be responsible for any initial shipping and insurance charges if the defective product(s) must be shipped for warranty service or warranty evaluation; however, Smart Life or a Smart Life Authorized Warranty Station will pay the return shipping charges if repairs are covered by the warranty. When returning parts for repair, you must include the model, type and serial number located on the rating plate. If any product submitted for warranty service is found to be ineligible, an estimate of repair cost will be furnished and the repair performed only if requested by the owner and upon receipt of payment or acceptable arrangements for payment.

Further limitations and exclusions:

Any warranty that may be implied in connection with your purchase or use of the vacuum, including any warranty of Merchantability or any warranty of Fitness For A Particular Purpose is limited to the duration of this limited warranty. Some states do not allow limitations on how long an implied warranty lasts, so the above limitations may not apply to you.

Your relief for the breach of this warranty is limited to the relief expressly provided above. In no event shall the manufacturer be liable for any consequential or incidental damages you may incur in connection with your purchase or use of the vacuum. Some states do not allow the exclusion or limitation of incidental or consequential damages, so the above limitation or exclusion may not apply to you. This warranty gives you specific legal rights. You may also have other rights, which may vary by state.

Problem solving



Make sure vacuum cleaner is off and charging plug is unplugged.

NOTICE : Thermal cut-off

This vacuum cleaner has a special thermostat that protects the vacuum cleaner in case of motor overheating. **If the vacuum suddenly shuts off**, proceed as follows: 1) Check the vacuum for a possible source of overheating such as a full dust cup, blocked wand or clogged filters. If these conditions are found, fix them and wait at least 30 minutes before attempting to use the vacuum. 2) After the **30 minute** period, press the power button. If the vacuum still does not work, call the Customer Service **HELPLINE**

Problem	Solution
Motor will not start	<ul style="list-style-type: none">• Make sure cleaner is fully powered.• Push charger securely into electrical outlet, try another outlet or check circuit breaker.• See detailed “thermal cut-off” instructions above.
Charging indicator lights are not lit while charging	<ul style="list-style-type: none">• Make sure charger is securely inserted into electrical outlet.• Make sure charging plug is securely inserted into hand vac.• Indicator lights stop blinking when fully charged.
Not enough suction power	<ul style="list-style-type: none">• Make sure MAX power mode is on• Empty dust cup and clean or change filters. See page 9 for maintenance instructions.• Make sure cleaner is fully powered. Charge battery.• Remove clogs that restrict the airflow.
Not enough running time	<ul style="list-style-type: none">• Make sure cleaner is fully powered.• Charge battery for 4 hours before using.
Brushroll indicator is red or brushroll will not turn	<ul style="list-style-type: none">• Check brushroll for debris. See page 9 for maintenance instructions.

Discarding the vacuum and battery pack



Before you discard this vacuum, dispose of battery in an environmentally safe manner. Do not discard battery with your regular household trash.



Important battery disposal information.

To find a disposal location nearest you.

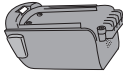

To preserve natural resources, please recycle or dispose of expired battery pack properly. This product contains a lithium-ion battery. It must be disposed of properly. Local laws may prohibit disposal of lithium-ion batteries in ordinary trash. Consult your local waste authority for information regarding available recycling and/or disposal options.

Image**Part name**

Battery

Part No. BAT1001

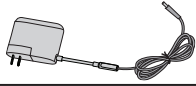

Charger

Part No. CBL1046

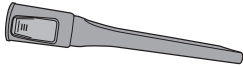

Crevice tool

Part No. NZL9402



Foam and fiber filters

Part No. FLT151



Post-motor filter

Part No. FLT152

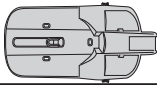

Wall mount

Part No. TLS9759

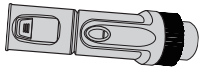

2-in-1 upholstery tool

Part No. NZL9400



Motorized floor nozzle

Part No. NZL9401