

# Breville®



## BLEND › ACTIVE®

selection of recipes **included**

Here to help...



0161 621 6900



enquiriesEurope@jardencs.com



[www.breville.co.uk](http://www.breville.co.uk)



[www.breville.co.uk/faqs](http://www.breville.co.uk/faqs)

Find Breville UK at...



YouTube

For hints, tips and over 200 recipes, visit...

creative  
kitchen

[www.brevillecreativekitchen.co.uk](http://www.brevillecreativekitchen.co.uk)



## READ CAREFULLY AND KEEP FOR FUTURE REFERENCE

**This product can be used by children aged 8 years and above, and persons who require supervision, provided:**

- **they are familiar with the hazards associated with the product, and,**
- **they receive instruction by a competent person on how to safely use the product.**

**Children must not play with the product. Cleaning and user maintenance must not be done by children unless they are aged 8 or older and are supervised.**

**Always disconnect the appliance from the mains supply socket if it is left unattended and before assembling, disassembling or cleaning.**

**If the supply cord is damaged, it must be replaced by the manufacturer, its service agent or similarly qualified persons in order to avoid a hazard.**

- △ Never use this appliance for anything other than its intended use. This appliance is for household use only. Do not use this appliance outdoors.
- △ Always ensure that hands are dry before handling the plug or switching on the appliance.
- △ Always use the appliance on a stable, secure, dry and level surface.
- △ This appliance must not be placed on or near any potentially hot surfaces (such as a gas or electric hob).
- △ Never immerse any part of the appliance or power cord and plug in water or any other liquid.
- △ Never let the power cord hang over the edge of a work top, touch hot surfaces or become knotted, trapped or pinched.
- △ Do not use the appliance if it has been dropped or if there are any visible signs of damage or if it is leaking.
- △ Never use any accessory or attachment not recommended by the manufacturer.
- △ Make sure that all attachments are securely and correctly fitted before operating the appliance.
- △ The blades have very sharp edges. Take care when handling or cleaning them.
- △ Allow moving parts to come to a stop before changing or cleaning accessories.
- △ Never process hot or boiling liquids. Allow them to cool before processing.



**▲ Ensure that the appliance is switched off and unplugged from the supply socket if it is left unattended and before assembling, disassembling or cleaning.**

**The blades have very sharp edges. Take care when handling or cleaning them.**

**Never immerse any part of the appliance or power cord and plug in water or any other liquid.**

**Never use harsh, abrasive or caustic cleaners to clean this appliance.**

1. Remove your Blend-Active® blender carefully from the box. You may wish to store the packaging for future use.
2. Check the contents:
  - Motor unit
  - Blade assembly
  - Bottle (quantity and size according to model purchased)
  - Resealable lid (quantity according to model purchased)
3. Wash all parts that will come into contact with food. Use warm soapy water then rinse and dry thoroughly.
4. Using a mild detergent solution, wipe the motor unit with a damp cloth. Dry thoroughly.

# features

---

**1 Sports-style resealable lid**

The lid has a cap which 'clicks' securely into place to seal the bottle and also folds all the way back until it 'clicks' into the open position preventing it from closing when in use.

**2 Blade assembly**

The durable high quality stainless steel blades are able to crush ice. Always add a small amount of liquid (such as fruit juice, water, etc.) when crushing ice. Dishwasher safe.

**3 Motor unit**

**4 Blend button**

Press to operate your Blend-Active® blender.

**5 600ml bottle**

**6 300ml bottle**

Blend-Active® blender bottles are made from Eastman Tritan® copolyester which is a durable BPA-free, odour, taste and stain resistant material used for manufacturing sports bottles and able to withstand extreme use and repeated dishwasher cleaning.

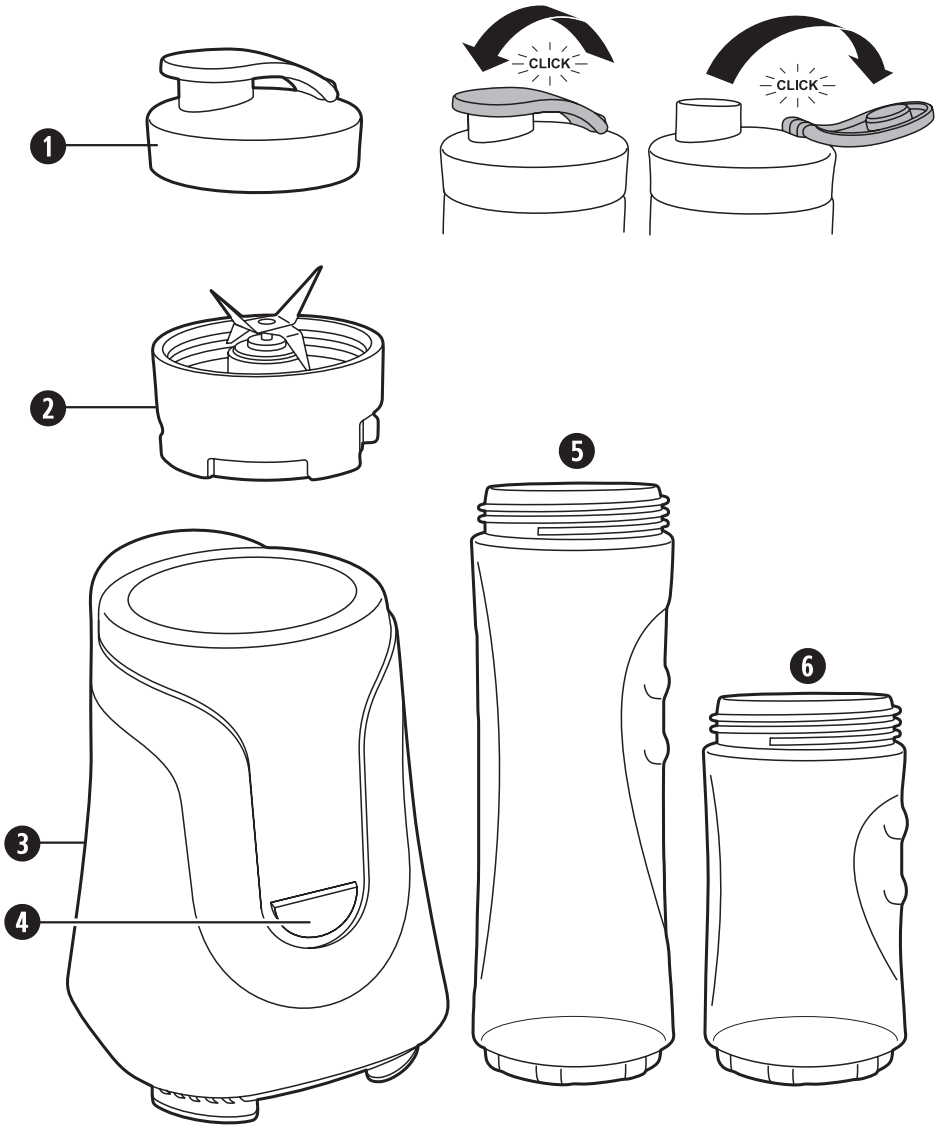

Due to our policy of continuous improvement, the actual product may differ slightly from the one illustrated in these instructions.

# using your Blend-Active® blender

---

**▲ Ensure that the appliance is switched off and unplugged from the supply socket if it is left unattended and before assembling, disassembling or cleaning.**

**The blades have very sharp edges. Take care when handling or cleaning them.**

**Never attempt to fit the blade assembly onto the motor unit by itself.**

**Do not operate your Blend-Active® blender continuously for more than 30 seconds without giving it a rest period of one minute. Take care if processing hot food.**

1. Add the ingredients to the bottle. Don't fill the bottle above the 600ml mark (or 300ml mark if you are using 300ml bottles).
2. Fit the blade assembly onto the bottle. Tighten the blade assembly firmly.
3. Turn the bottle upside down so that the blade assembly is at the bottom then line up the ● symbol on the blade assembly with the ■ symbol on the rim of the motor unit.
4. Gently press the bottle downwards then twist it clockwise until the ● symbol on the blade assembly is aligned with the ■ symbol on the rim of the motor unit. Your Blend-Active® blender will not work unless the bottle is correctly locked into position.
5. Press and hold the blend button to operate your Blend-Active® blender. You can either press and hold the button or use short pulses until your drink is at the desired consistency.
6. When you have finished blending your drink, twist the bottle anticlockwise until the ● symbol is aligned with the ■ symbol and remove the bottle and blade assembly. Turn the bottle the right side up then unscrew the blade assembly and fit one of the resealable lids onto the bottle. Close the cap of the resealable lid firmly until it "clicks".

**Notes:** If the ingredients become stuck around the blade during processing, simply remove the bottle from the motor unit, give it a shake then refit it and carry on processing. Always remove the bottle when attempting to agitate or otherwise redistribute the ingredients.



For ease of cleaning, we recommend that you clean your blend active bottle and cap as soon as you have finished using them.

## Crushing ice

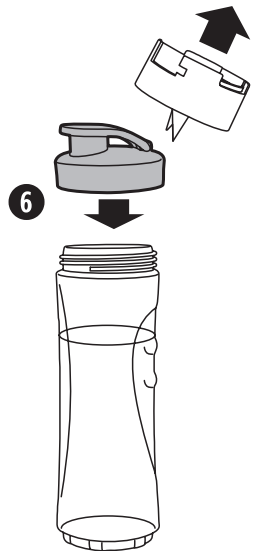
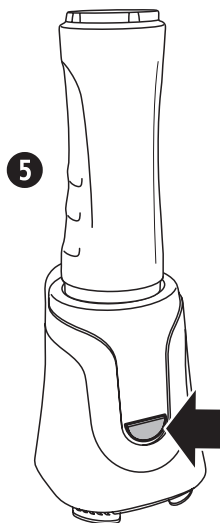
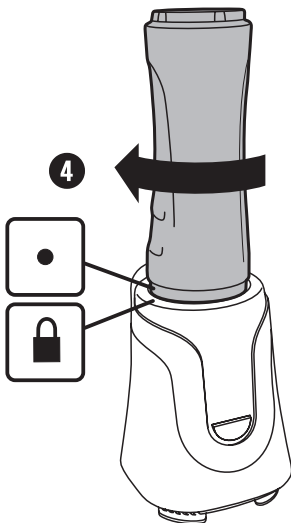
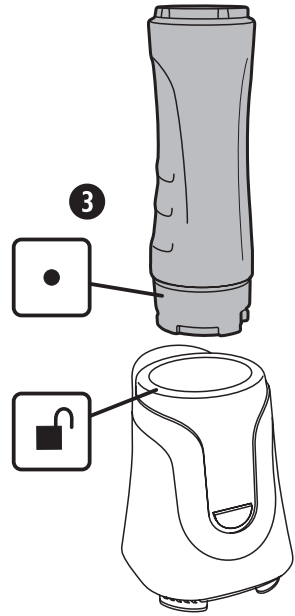
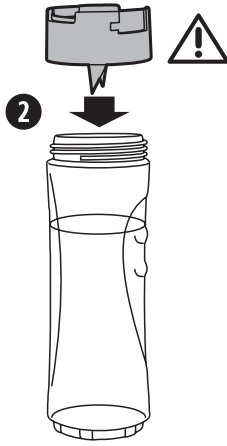
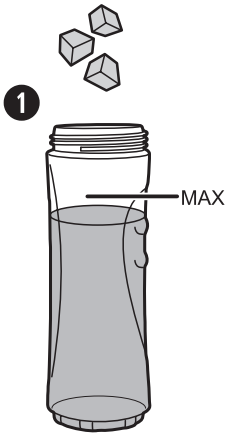
Your Blend-Active® blender can be used to crush ice. For best results and to prevent possible damage to the blades, always add a small amount of liquid to the ice before processing. The liquid can be water or one of the liquid ingredients from your recipe (fruit juice, etc.).



## Recipe icons

	Ideal for children.
	Quantities in the recipe are for the 600ml bottle.
	The recipe quantities can be halved and made in the 300ml bottle. Great for children's recipes and when smaller quantities are required.

Smoothies and shakes often separate if not consumed immediately after blending. However, they can be re-blended and consumed within 30 minutes if necessary.

## Ingredients

- Peanut butter—a great protein shake ingredient. Try and source an unsweetened variety.
- Frozen berries—now widely available in larger supermarkets. Look out for special packs of frozen smoothie mixes too.
- Protein powder—a concentrated form of protein. Used as a dietary supplement, protein powder can be added to drinks, sprinkled on cereal, stirred into soups and stews, or cooked into baked goods and other meals. Available from most large supermarkets or health shops.
- Almond Milk—a healthy alternative to cow's milk.
- Soya Milk—can be used as a skimmed milk replacement in all of our recipes.

## To make a recipe...

Simply add the ingredients in the recipe to the bottle and blitz until thick and smooth. Remember to halve the ingredients if you are using the 300ml bottle.

creative  
kitchen

Visit Creative Kitchen for access to the best cooking techniques, mouth-watering meals, entertaining ideas and videos to help take you from part-time cook to expert chef in minutes. Enjoy getting creative with your home cooking at [www.brevillecreativekitchen.co.uk](http://www.brevillecreativekitchen.co.uk).





## PROTEIN SHAKES

### Protein Rich Shake

600 OR 300

- 300ml skimmed milk
- 2 tbsp unsweetened peanut butter
- 1 small ripe banana, broken into chunks
- 1 large handful of frozen berries
- 2 tbsp oatmeal

### Good Morning

600 OR 300

- 300ml skimmed milk
- 1 tsp instant coffee
- 30g Vanilla Protein powder

### Berry Blitz

600 OR 300

- 1 large handful of frozen or fresh berries
- 30g vanilla protein powder
- 300ml skimmed milk
- 6 ice cubes

### Chocolate and Banana

600 OR 300

- 300ml skimmed milk
- 1 tbsp unsweetened peanut butter
- 30g chocolate protein powder
- 1 small ripe banana

## SMOOTHIES

### Super Thick Berry

600 OR 300 

- 300ml chilled apple juice
- 100ml plain natural yoghurt
- 1 small ripe banana
- 1 handful of frozen berries
- 1 tbsp honey (optional)

### Raspberry Crush

600 OR 300 

- 300ml chilled freshly squeezed orange juice
- 1 handful of fresh or frozen raspberries
- 75g Raspberry sorbet
- Mint leaves to garnish

### Tropical Fruit

600 OR 300 

- 1 small ripe mango, peeled and diced
- 1 kiwi fruit, peeled and cut into chunks
- 1 passion fruit, seeds scooped out
- 200ml of light coconut milk
- 100ml concentrated tropical juice
- Juice of half a lime
- Handful of ice

### Kiwi and Berry Bliss

600 OR 300

- 1 large handful of frozen berries/blueberries
- 1 kiwi fruit, peeled and diced
- 1 small banana, peeled and broken into chunks
- 300ml fresh fruit juice



## DAIRY-FREE SMOOTHIES

### Berry Blitz



- 300ml chilled almond milk
- 1 small ripe mango
- 1 small banana
- 1 handful of fresh or frozen berries

### Soya



- 300ml chilled soya milk
- 20g porridge oats
- 1 small banana, peeled and cut into chunks
- 7 large strawberries
- Few drops of vanilla extract
- 1 tbsp honey

## OTHER DRINKS

### Vanilla Milkshake



- 2 scoops of vanilla ice cream
- 300ml chilled semi skimmed milk

*Variations:*

**Chocolate**—Add 2 tbsp cocoa powder.

**Strawberry**—Add a handful of washed strawberries.

**Berry**—Add a large handful of fresh or frozen berries

### Carrot, Orange and Ginger Juice



- ½ inch fresh root ginger, peeled and finely sliced
- 1 medium sized carrot, scrubbed and finely sliced
- 1 large orange, peeled and chopped
- 300ml chilled fresh orange or carrot juice
- 6 ice cubes



**▲ Ensure that the appliance is switched off and unplugged from the supply socket if it is left unattended and before assembling, disassembling or cleaning.**

**Never immerse the motor unit or power cord and plug in water or any other liquid.**

**Never use harsh, abrasive or caustic cleaners to clean this appliance.**

**The blades have very sharp edges. Take care when handling or cleaning them.**

### Cleaning

- For ease of cleaning, we recommend that you clean your blend active bottle and cap as soon as you have finished using them.
- Clean the motor unit with a damp cloth only.
- Wash the blade assembly in warm, soapy water. Rinse and dry thoroughly. For stubborn food deposits stuck around the blade, carefully use a washing up brush. Alternatively, the blade assembly can be washed in a dishwasher.
- Wash the bottles and lids in warm, soapy water. Rinse and dry thoroughly. Alternatively, the bottles and lids can be washed in a dishwasher.

### Quick cleaning method

1. Half fill a bottle with warm water and a drop or two of detergent then fit the blade assembly. Fit the blade/bottle onto the motor body as described in the section *using your Blend-Active® blender*.
2. Press and hold the blend button for 10-20 seconds.
3. Remove the bottle, unscrew the blade assembly and rinse them both under running water.

### Storing

Store your Blend-Active® blender in its packing or in a clean, dry place. Ensure all parts are dismantled and keep the appliance out of the reach of children.

# connection to the mains supply



This appliance is fitted with either a moulded or rewirable BS1363, 13 amp plug. The fuse should be rated at 5 amps and be ASTA approved to BS1362.

If the fuse in a moulded plug needs to be changed, the fuse cover must be refitted. The appliance must not be used without the fuse cover fitted.

If the plug is unsuitable, it should be dismantled and removed from the supply cord and an appropriate plug fitted as detailed below. If you remove the plug it must not be connected to a 13 amp socket and the plug must be disposed of immediately.

The wires of the mains lead are coloured in accordance with the following code:

BLUE – NEUTRAL      BROWN – LIVE

The wire which is coloured Blue, must be connected to the terminal which is marked with the letter N or coloured Black.

The wire which is coloured Brown, must be connected to the terminal which is marked with the letter L or coloured Red.

If any other plug is used, a 5 amp fuse must be fitted either in the plug or adaptor or at the distribution board.

**CAUTION: DO NOT CONNECT EITHER WIRE TO THE EARTH TERMINAL IN THE PLUG WHICH IS MARKED E OR WITH THE EARTH SYMBOL ( $\perp$ ) OR COLOURED GREEN OR GREEN AND YELLOW.**



This symbol indicates that this unit is a Class II appliance and therefore an earth connection is not required.

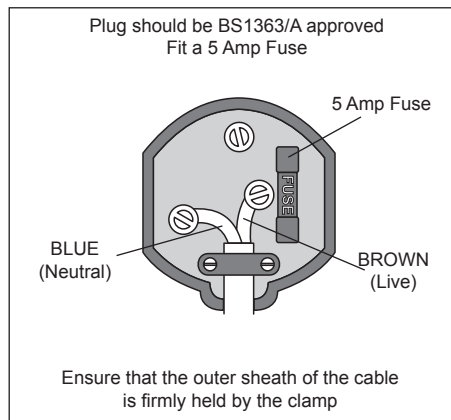



### **Replacement parts**

For additional or replacement bottles, please visit [www.breville.co.uk](http://www.breville.co.uk) or call us on **0161 621 6900**.

### **Troubleshooting**

For troubleshooting and FAQs visit [www.breville.co.uk/faqs](http://www.breville.co.uk/faqs)



These appliances are built to the very highest of standards. There are no user serviceable parts. Follow these steps if the unit fails to operate:

1. Check the instructions have been followed correctly.
2. Check that the fuse has not blown.
3. Check that the mains supply is functional.

If the appliance will still not operate, return the appliance to the place it was purchased for a replacement. To return the appliance to the Customer Service Department, follow the steps below:

1. Pack it carefully (preferably in the original carton). Ensure the unit is clean.
2. Enclose your name and address and quote the model number (located on the rating label) on all correspondence.
3. Give the reason why you are returning it.
4. If within the guarantee period, state when and where it was purchased and include proof of purchase (e.g. till receipt).
5. Send it to our Customer Service Department at the address below:

**Customer Service Department**

**Jarden Consumer Solutions (Europe) Limited  
5400 Lakeside, Cheadle Royal Business Park,  
Cheadle, SK8 3GQ, UK.**

**Telephone: 0161 621 6900 Fax: 0161 626 0391**

**e-mail: [enquiriesEurope@jardencs.com](mailto:enquiriesEurope@jardencs.com)**



Please keep your receipt as this will be required for any claims under this guarantee.

This appliance is guaranteed for 1 year after your purchase as described in this document.

During this guaranteed period, if in the unlikely event the appliance no longer functions due to a design or manufacturing fault, please take it back to the place of purchase, with your till receipt and a copy of this guarantee.

The rights and benefits under this guarantee are additional to your statutory rights, which are not affected by this guarantee. Only Jarden Consumer Solutions (Europe) Limited (“JCS (Europe)”) has the right to change these terms.

JCS (Europe) undertakes within the guarantee period to repair or replace the appliance, or any part of appliance found to be not working properly free of charge provided that:

- you promptly notify the place of purchase or JCS (Europe) of the problem; and
- the appliance has not been altered in any way or subjected to damage, misuse, abuse, repair or alteration by a person other than a person authorised by JCS (Europe).

Faults that occur through, improper use, damage, abuse, use with incorrect voltage, acts of nature, events beyond the control of JCS (Europe), repair or alteration by a person other than a person authorised by JCS (Europe) or failure to follow instructions for use are not covered by this guarantee. Additionally, normal wear and tear, including, but not limited to, minor discoloration and scratches are not covered by this guarantee.

The rights under this guarantee shall only apply to the original purchaser and shall not extend to commercial or communal use.

If your appliance includes a country-specific guarantee or warranty insert please refer to the terms and conditions of such guarantee or warranty in place of this guarantee or contact your local authorized dealer for more information.

Waste electrical products should not be disposed of with Household waste. Please recycle where facilities exist. E-mail us at [enquiriesEurope@jardencs.com](mailto:enquiriesEurope@jardencs.com) for further recycling and WEEE information.

Jarden Consumer Solutions (Europe) Limited  
5400 Lakeside  
Cheadle Royal Business Park  
Cheadle  
SK8 3GQ  
UK

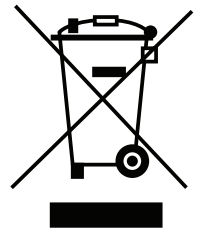



Jarden Consumer Solutions (Europe) Limited  
Cheadle Royal Business Park, Cheadle, SK8 3GQ, United Kingdom  
e-mail: [enquiriesEurope@jardencs.com](mailto:enquiriesEurope@jardencs.com)  
Telephone: 0161 621 6900

For Customer Service details, please see the website.

[www.breville.co.uk](http://www.breville.co.uk)

**© 2014 Jarden Consumer Solutions (Europe) Limited**

All rights reserved. Imported and distributed by Jarden Consumer Solutions (Europe) Limited,  
Cheadle Royal Business Park, Cheadle, SK8 3GQ, United Kingdom.

The product supplied may differ slightly from the one illustrated due to continuing product development.

Printed in China